

DYMO[®] MobileLabeler[™]



User Guide



Copyright

© 2017 Newell Rubbermaid Europe LLC. All rights reserved. Revised 2/9/17

No part of this document or the software may be reproduced or transmitted in any form or by any means or translated into another language without the prior written consent of Newell Rubbermaid Europe LLC.

Trademarks

DYMO is a registered mark in the U.S. and other countries.

Apple and the Apple logo are trademarks of Apple Inc., registered in the U.S. and other countries. App Store is a service mark of Apple Inc.

IOS is a trademark or registered trademark of Cisco in the U.S. and other countries.

The Bluetooth® word mark and logos are registered trademarks owned by the Bluetooth SIG, Inc. and used under license.

Android, Google Play and the Google Play logo are trademarks of Google Inc.

All other trademarks are the property of their respective holders.

“Made for iPhone” and “Made for iPad” mean that an electronic accessory has been designed to connect specifically to iPhone or iPad, respectively, and has been certified by the developer to meet Apple performance standards. Apple is not responsible for the operation of this device or its compliance with safety and regulatory standards. Please note that the use of this accessory with iPhone or iPad may affect wireless performance.

1	About Your New Label Maker
1	Registering Your Label Maker
1	Wireless Safety Warnings
2	Safety Precautions for Lithium-Polymer Rechargeable Battery
2	General Safety Precautions
4	Getting to Know the Label Maker
5	Power
5	Power Status Light
5	Battery Status Light
5	Bluetooth Connection
6	Bluetooth Status Light
6	RESET
7	Getting Started
7	Connecting the Power
7	Inserting the Battery
7	Removing the Battery
8	Charging the Battery
9	Inserting the Label Cassette
9	Cutting the Labels
10	Printing Labels from a Mobile Device
10	Pairing the Label Maker to your Mobile Device
10	Downloading the DYMO Connect App
11	About the DYMO Connect Mobile App
11	Home Screen
11	Design Screen
12	Printing Labels from your Computer
12	Downloading and Installing DYMO Label Software
12	Connecting your Label Maker to your Computer
13	About DYMO Label Software
13	Label Maker Status
14	Caring for the Label Maker
14	Cleaning the Cutter Blade
15	Cleaning the Print Head
16	Troubleshooting
16	General
18	Bluetooth Connection
19	Technical Specifications
20	Documentation Feedback
20	Environmental Information

About Your New Label Maker

With the DYMO® MobileLabeler electronic label maker, you can create a wide variety of high-quality, self-adhesive labels and print using **Bluetooth®** wireless technology from your Apple® or Android™ mobile device. You can also print from your Windows® or Mac computer using Bluetooth wireless technology or the included USB cable.

You can choose to print your labels in many different fonts, font sizes, and styles. The label maker uses DYMO D1 label cassettes in widths of 6 mm (1/4"), 9 mm (3/8"), 12 mm (1/2"), 19 mm (3/4"), or 24 mm (1"). Labels are available in a wide range of colors.

Visit www.dymo.com for information on obtaining labels and accessories for your label maker.

Registering Your Label Maker

Visit www.dymo.com/register to register your label maker online. During the registration process, you will need the serial number, which is located on the bottom of the label maker. See Figure 1 on page 4.

Register your label maker to receive these benefits:

- An additional one year of warranty
- Email notification of free software upgrades
- Special offers and new product announcements

Wireless Safety Warnings

Nearly every electronic device is susceptible to electromagnetic interference (EMI) if inadequately shielded, designed, or otherwise configured for electromagnetic compatibility.

Similar to a mobile phone, your DYMO device is a low power transmitter/receiver and is covered by regulations pertaining to such devices.

- Turn off your DYMO device in any facility where posted notices instruct you to do so. These facilities may include hospitals or health care facilities that may be using equipment that is sensitive to external RF energy.
- Observe all signs and instructions that require an electrical device or RF radio product to be switched off in designated areas, such as gas/refueling stations, hospitals, blasting areas, potentially explosive atmospheres, or aircraft.
- Some Bluetooth devices may interfere with some hearing aids. In the event of such interference, you may want to consult your hearing aid manufacturer or physician to discuss alternatives.
- If you use any other personal medical device, consult the manufacturer of your device to determine if it is adequately shielded from RF energy. Your doctor or physician may be able to assist you in obtaining this information.
- If you are in doubt about whether your device can be safely turned on or used, please consult an authorized person in the location you want to use your device. If no authorized person is available or you remain uncertain, DYMO recommends that you turn off your Bluetooth device.

Safety Precautions for Lithium-Polymer Rechargeable Battery

Battery Type: LiPolymer 7.4V 1500mAh 11.1Wh

Improper handling of a lithium-polymer rechargeable battery may cause leakage, heat, smoke, an explosion, or fire. This could cause deterioration of performance or failure. This may also damage the protection device installed in the battery. This could damage equipment or injure users. Thoroughly follow the instructions below.

⚠ Danger

- Use the battery only in the MobileLabeler label maker.
- Battery can only be charged while inserted in the label maker using the charging adapter provided (9VDC/4A).
- Do not connect directly to an electric outlet or cigarette lighter charger.
- Do not store battery close to fire or inside the car where temperature may be over 140°F (60°C).

⚠ Warning

- Stop charging the battery if charging is not completed within three hours.

⚠ Caution

- Do not use the label maker or battery in a place that generates static electricity.
- Use the label maker only at room temperature.
- Battery can only be charged within +50°F~86°F (+10°C~30°C) temperature range.

General Safety Precautions

Follow the guidelines in this section to use this product safely. In addition, make sure to read the **Safety Precautions for Lithium-Polymer Rechargeable Battery** on page 2.

Charging Adapter and Power Cord

- Only use the charging adapter and power cord that came with the label maker.
- Do not handle charging adapter or power cord if your hands are wet.
- Do not cut, damage, alter, or place heavy objects on the charging adapter or power cord.
- Do not use the charging adapter or power cord if either are damaged.

Label Maker

- Only use the USB cable that came with the label maker.
- Do not insert objects into or block the label exit slot.
- Do not touch the cutter blade. Personal injury could result.
- Do not allow any liquids to come into contact with the label maker.
- Do not disassemble the label maker. For inspection, adjustment, or repair, contact DYMO Customer Support (<http://support.dymo.com>).

- Unplug the power cord immediately if you notice any abnormal odor, heat, smoke, discoloration, deformation, or anything unusual while the label maker is in use.

DYMO D1 Label Cassettes

- Use only DYMO-branded D1 label cassettes in this label maker.
- Do not use any unauthorized accessories or supplies.
- Clean the surface before applying the adhesive label or the label may not adhere correctly and could peel off easily.
- Do not expose the labels to extreme heat or sunlight.

Getting to Know the Label Maker

Become familiar with the features shown in the following figure.

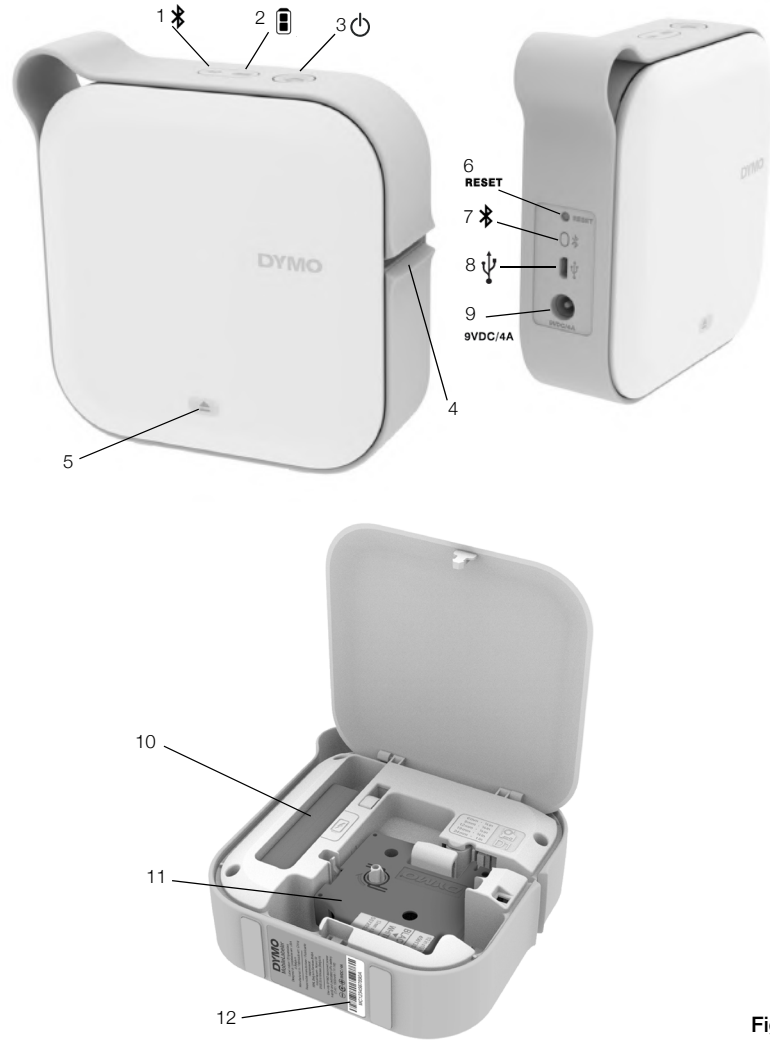





Figure 1

- | | | |
|---------------------------|---------------------------|--|
| 1 Bluetooth status | 5 Press to open | 9 Power connector |
| 2 Battery status | 6 RESET button | 10 Battery |
| 3 Power button | 7 Bluetooth button | 11 Label cassette |
| 4 Label exit slot | 8 USB port | 12 Serial number/
Regulatory label |

Power

The  button turns the label maker power on and off. A short press of the  button turns the power on. A long press turns the power off.

A short press of the  button will also cancel any ongoing print job.

After a period of inactivity, the printer will enter a power-saving standby mode. The period of time before entering standby mode will vary based on your mobile device.

Power Status Light



 The power status light visually shows the power status of the label maker.

Status Light	Power Status
Off	The power is turned off; the battery may still be charging if plugged into a wall outlet.
Glowing	The label maker is in standby mode.
Fast Blinking	The label maker is on and there is an error.
Solid	The power is turned on.

When the label maker is turned on but not connected to a power source, the power status light remains on but is dimmed.

Battery Status Light

 The battery status light visually shows the charge status of the battery.

Status Light	Label Maker Status
Off	The battery is empty.
Moving	The battery is charging.
Solid	 The battery is fully charged.  The battery is partially charged.

Bluetooth Connection

The label maker can connect to a maximum of two devices using Bluetooth wireless technology. For example, two phones, a phone and a tablet, or a laptop and a phone.

By default, the label maker is always discoverable when the power is turned on. You can change the label maker's discoverability through MobileLabeler Options in DYMO Label software.

- **General** - Always discoverable.
- **Limited** - Discoverable for two minutes.
- **Off** - Never discoverable.

When set to limited discoverability, the two minute discoverable time period can be started by pressing the Bluetooth  button on the back of the label maker.

To change the discovery mode

- 1 Connect the MobileLabeler label maker to the computer where you have DYMO Label software installed.
- 2 From DYMO Label software, select the MobileLabeler label maker as the current printer.
- 3 Click  to open MobileLabeler Options.
- 4 Select the desired discovery option.



Bluetooth Status Light

✦ The Bluetooth status light visually shows the connection status of the label maker.

Status Light	Label Maker Status
Off	The label maker is not discoverable.
Blinking	The label maker is discoverable.
Solid	The label maker is connected.

RESET

The RESET button resets the label maker to the factory default settings. Resetting the label maker results in the loss of all current settings, including all Bluetooth settings. Press this button only if you want to erase all current information on the label maker.

To press the RESET button, use a narrow pointed object such as the tip of a pen or pencil.

Getting Started

Follow the instructions in this section to set up your label maker.

Connecting the Power

The label maker is powered by a rechargeable, lithium-polymer (LiPo) battery . The battery included with your label maker comes partially charged.



For best performance, fully charge the battery before using your label maker.

Inserting the Battery



Make sure all cables are disconnected before inserting the LiPo battery.

To insert the battery

- 1 Press  and then lift to open the side cover of the label maker.
- 2 Insert the battery into the battery compartment as shown in Figure 2.
- 3 Close the side cover of the label maker.



Make sure to read the LiPo Safety Precautions found on page 2.



Figure 2

Removing the Battery

Remove the battery when the label maker will not be used for more than seven days.



Make sure all cables are disconnected before removing the LiPo battery.

To remove the battery

- 1 Press  and then lift to open the side cover of the label maker.
- 2 Remove the battery from the battery compartment as shown in Figure 3.



Make sure to read the LiPo Safety Precautions found on page 2.



Figure 3

Charging the Battery

The battery can only be charged using the DYMO charging power adapter included with the label maker. Fully charging the battery will take approximately 2.5 to 3 hours.

For best performance, fully charge the battery before using your label maker.

 Make sure to read the LiPo Safety Precautions found on page 2.

To charge the battery

- 1 Make sure the battery is inserted in the label maker.
- 2 Plug the power cord into the power adapter as shown in Figure 4.
- 3 Plug the power adapter into the power connector on the back of the label maker and plug the power cord into a power outlet. See Figure 5.

Movement of the battery status lights indicate that the battery is charging. The battery continues to charge even if you turn the label maker off.

The battery status lights stop moving and are both on when the battery is fully charged.



Figure 4



Figure 5

Inserting the Label Cassette

Your label maker uses DYMO D1 label cassettes. Visit www.dymo.com for information about purchasing additional label cassettes.

To insert the label cassette

- 1 Press  and then pull outward to open the side cover of the label maker.
- 2 Make sure the tape and ribbon are taut across the mouth of the cassette and that **the tape passes under the label guides**. See Figure 6.
If necessary, turn the ribbon rewind spool clockwise to tighten the ribbon. See Figure 7.
- 3 Insert the cassette and press firmly until the cassette clicks into place.
- 4 Close the side cover of the label maker.

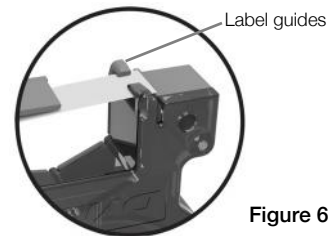

Figure 6

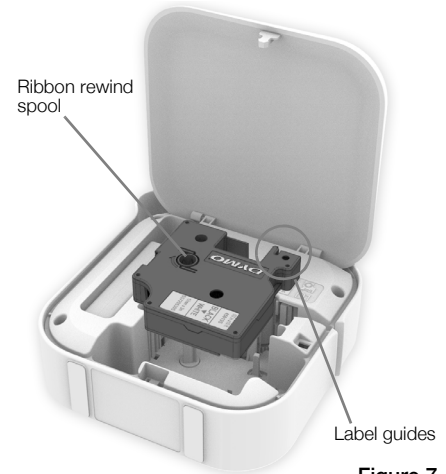



Figure 7

Cutting the Labels

The label maker has an automatic cutter which will cut the label after each label is printed. Clear the label exit slot of labels after every 10 labels to prevent a label jam.

Printing Labels from a Mobile Device

You can design and print labels from the MobileLabeler label maker using the DYMO Connect mobile app.

 DYMO Connect is recommended for use with recently released versions of Android and iOS mobile devices.

Pairing the Label Maker to your Mobile Device

Pair the label maker to your mobile device using Bluetooth settings on your device. The label maker displays in your list of Bluetooth devices with the name **DYMO ML xxxx** where xxxx is unique for every label maker.

 If you are asked for a pairing code, use 0000.

Pairing with an iOS device

- 1 In Settings, turn on the Bluetooth setting.
- 2 Tap **DYMO ML xxxx** under **MY DEVICES** to connect the label maker.
After a few seconds, **Connected** is displayed when pairing is complete.



Pairing with an Android device

- 1 In Settings, turn on the Bluetooth setting.
- 2 Tap **DYMO ML xxxx** under **Available devices** to pair the label maker.
After a few seconds, is listed under **Paired devices** when pairing is complete.

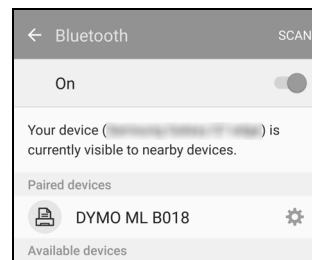

Downloading the DYMO Connect App

The DYMO MobileLabeler label maker works wirelessly with the DYMO Connect mobile app available on the Apple® App store or the Google Play™ store.



About the DYMO Connect Mobile App

Learn about the features available in the DYMO Connect mobile app.

Home Screen

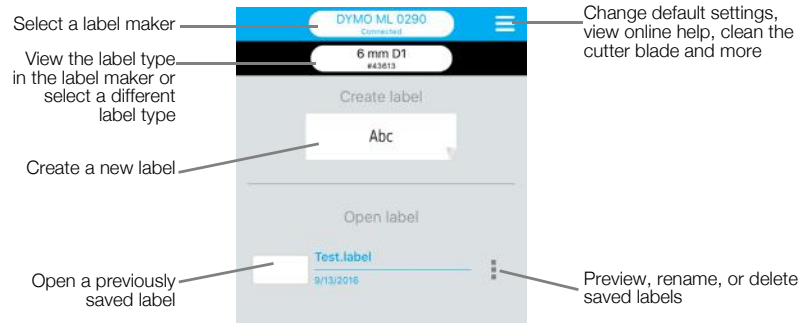

Design Screen

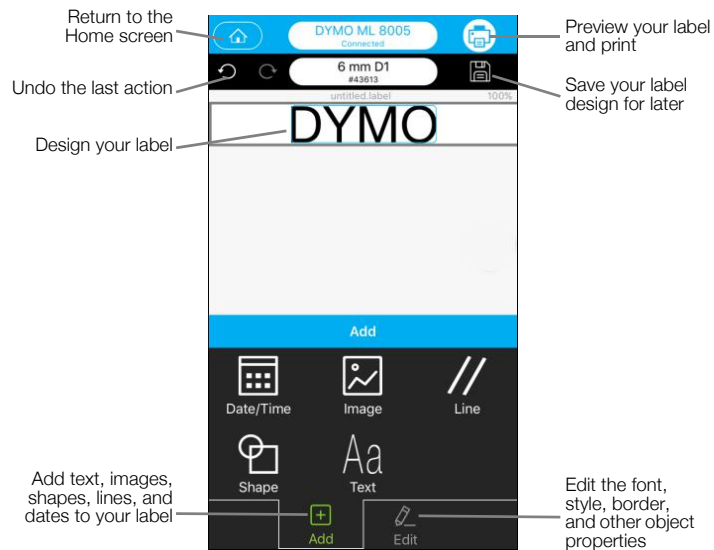

From the DYMO Connect menu , you can view the DYMO Connect Help for more information.

Printing Labels from your Computer

The label maker can connect to your computer using Bluetooth wireless technology or the USB cable supplied with the label maker.

Downloading and Installing DYMO Label Software

You can print to the label maker from DYMO Label software.

To install the software on a Windows® system

- 1 Download the latest version of DYMO Label software from the Support section of the DYMO Web site at support.dymo.com.
- 2 Close all open Microsoft Office applications.
- 3 Double-click the installer icon.
After a few seconds, the installation screen appears.
- 4 Click **Install** and follow the instructions in the installer.

To install the software on a Mac

- 1 Download the latest version of DYMO Label software from the Support section of the DYMO Web site at support.dymo.com.
- 2 Double-click the installer icon and follow the on-screen instructions.

Connecting your Label Maker to your Computer

The label maker connects to your computer using the USB connection located on the back of the label maker.

Use only the USB cable included with your label maker.

To connect the label maker to your computer

- 1 Plug the USB cable into the USB port on the back of the label maker.
- 2 Plug the other end of the USB cable into a USB port on your computer.



Figure 8

About DYMO Label Software

The following figure shows some of the major features available in DYMO Label software.

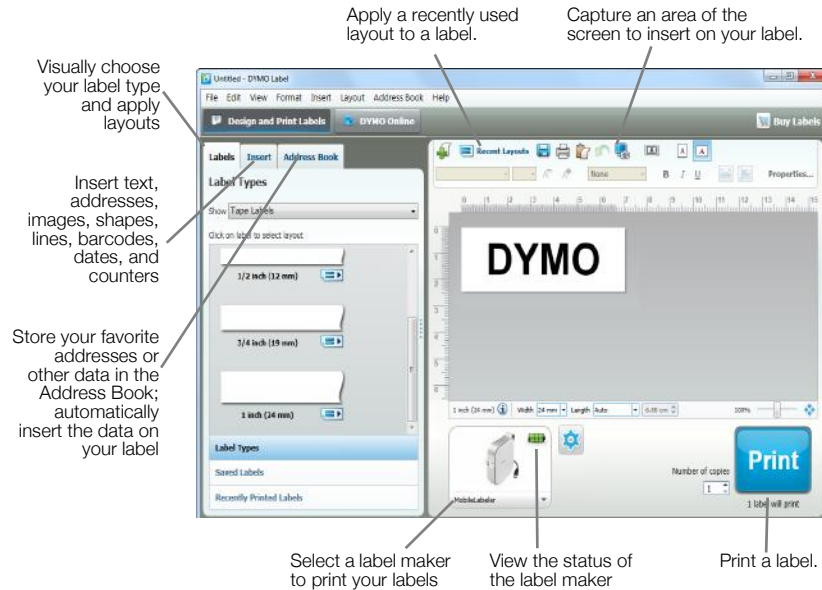

For complete details on using the software, refer to the online Help or the *DYMO Label Software User Guide*.

From the Help menu in DYMO Label software, you can view the following:

- DYMO Label Help
- DYMO Label User Guide

Label Maker Status

The label maker status is displayed in DYMO Label software window. The following table describes the possible states of the label maker.

	Label maker is connected and battery is charging
	Label maker is connected and battery is not charging
	Label maker is connected and there is a problem with the battery

When the Bluetooth symbol is present, the label maker is connected using Bluetooth technology. Otherwise, the label maker is connected using the USB cable.



Caring for the Label Maker

Your label maker is designed to give you long and trouble-free service, while requiring very little maintenance. Clean your label maker regularly to keep it working properly.

Cleaning the Cutter Blade

Clean the cutter blade each time you replace the label cassette.

To clean the cutter blade

- 1 Press  and then lift to open the side cover of the label maker.
- 2 Remove the label cassette.
- 3 Make sure the label maker is turned on and paired to the mobile device running DYMO Connect.
- 4 Open DYMO Connect and tap .
- 5 Tap **Cutter cleaning** and then **Expose cutter blade**.

The cutter blade will advance into a position where you can clean both sides.

- 6 Use a cotton ball and alcohol to clean both sides of the blade.



The cutter blade is extremely sharp. Use caution when cleaning.

- 7 After cleaning the blade, tap **Hide cutter blade** in DYMO Connect.

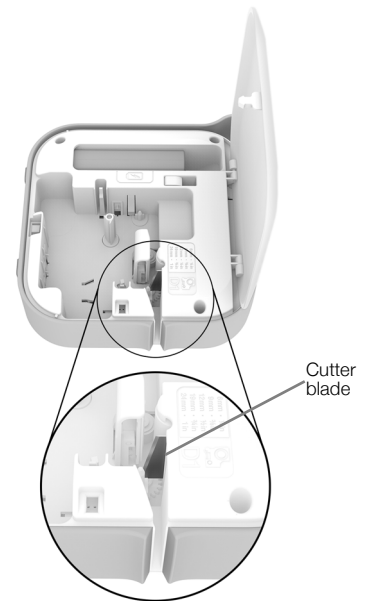



Figure 9

Cleaning the Print Head

The print head is very delicate, so use care when cleaning.

To clean the print head

- 1 Disconnect the power adapter, if connected.
- 2 Press  and then lift to open the side cover of the label maker.
- 3 Remove the label cassette and battery.
- 4 Use a small, soft brush or cotton swab to wipe away dust and other stray particles from the inside of the label compartment.
- 5 Remove the cleaning tool from inside the label compartment cover.

If you do not have a cleaning tool, contact DYMO Customer Care (<http://support.dymo.com>).

- 6 Gently wipe the padded side of the tool across the print head. See Figure 10.
- 7 Insert the label cassette and close the cover.

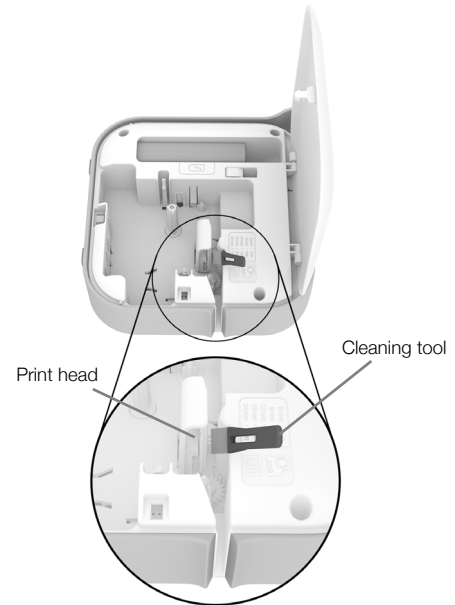

Figure 10

Problem/Error Message	Solution
Poor print quality	<ul style="list-style-type: none"> ■ Use only DYMO-branded D1 label cassettes. ■ Attach the charging adapter to the label maker to recharge the battery. See Charging the Battery. ■ Clean the print head. See Cleaning the Print Head. ■ Ensure the label cassette is inserted properly. ■ Replace the label cassette.
Poor cutter performance	<ul style="list-style-type: none"> ■ Use only DYMO-branded D1 label cassettes. ■ Clean the cutter blade. See Cleaning the Cutter Blade.
Label maker error; power LED is blinking quickly	<ul style="list-style-type: none"> ■ Ensure the label cassette is inserted properly and not jammed or empty. ■ Ensure the battery is inserted properly. ■ Ensure the cover is closed. ■ Recharge the battery. See Charging the Battery.
Label maker does not turn on	<ul style="list-style-type: none"> ■ Ensure the battery is inserted properly. ■ Ensure the label maker is connected to a working wall outlet. ■ Recharge the battery. See Charging the Battery.
Label maker does not print	<ul style="list-style-type: none"> ■ Ensure the label cassette is inserted properly. ■ Battery charge level may be too low to print. <ul style="list-style-type: none"> • Recharge the battery and reprint the label. See Charging the Battery.
Battery is not charging	<ul style="list-style-type: none"> ■ Ensure the battery is inserted. ■ Ensure the label maker is connected to a working wall outlet. See Charging the Battery.
Battery level is low	<ul style="list-style-type: none"> ■ Recharge the battery. See Charging the Battery.

Bluetooth Connection

Many connection issues can be resolved quickly by disconnecting the power adapter, and removing and reinserting the battery.



For safety, all cables must be disconnected when handling the LiPO battery.

Problem	Solution
Label maker status is Not connected or does not appear in the printer list in the DYMO Connect mobile app	<ul style="list-style-type: none">■ Make sure the label maker power is turned on.■ Make sure the label maker is paired in your device's settings.■ Quit DYMO Connect and restart the app.
Paired label maker will not connect in my device's Bluetooth settings	<ul style="list-style-type: none">■ Make sure the label maker power is turned on.■ Unpair the label maker from your mobile device and then pair again: iOS<ul style="list-style-type: none">• Tap DYMO ML xxxx and tap Forget this device.Android<ul style="list-style-type: none">• Tap DYMO ML xxxx and tap Unpair.
Authentication error	<p>Perform a hard restart of the label maker.</p> <ol style="list-style-type: none">1 Turn off the label maker.2 Disconnect the power adapter and remove the battery.3 Reinsert the battery and reconnect the power adapter.4 Turn the label maker on.

If you need further assistance, visit the Support section of the DYMO Web site at <http://support.dymo.com>.

Technical Specifications

DYMO MobileLabeler label maker

Dimensions (WHD)	2.18" x 5.8" x 5.75" (55.4 mm x 147.2 mm x 146 mm)
Weight (without battery)	17.4 ounces (494 grams)
Maximum print width	3/4" (19 mm)
Maximum label width	1" (24 mm)
Label type	DYMO D1 label cassettes
Battery	LiPolymer 7.4V 1500mAh 11.1Wh
Power adapter	9 VDC, 4 Amp
Print method	Thermal transfer
Print resolution	300 dpi
USB	USB 2.0 Full speed
Bluetooth® version	BR/EDR V2.1 or newer
Bluetooth® range	≤ 32 feet (10 meters)
Regulatory approvals	FCC, IC, TUV CB, RCM, R-NZ, RoHS, REACH
Warranty	2 year limited (refer to Quick Start Guide for full warranty statement)

Documentation Feedback

We are constantly working to produce the highest quality documentation for our products. We welcome your feedback.

Send us your comments or suggestions about our user guides. Include the following information with your feedback:

- Product name, model, and User Guide page number
- Brief description of instructions that are inaccurate or unclear, areas where more detail is needed, and so on

We also welcome your suggestions about additional topics you would like to see covered in the documentation.

Send email messages to: dymo.docfeedback@newellco.com

Keep in mind that this email address is only for documentation feedback. If you have a technical question, contact DYMO Customer Care (<http://support.dymo.com>).

Environmental Information

The equipment that you have bought requires the extraction and use of natural resources for its production. It may contain substances that are hazardous to health and the environment.

In order to avoid the dissemination of those substances in our environment, and to diminish the pressure on natural resources, we encourage you to use the appropriate take-back systems. These systems will reuse or recycle most of the materials of your end-of-life equipment in an environmentally sound way.

The crossed-bin symbol marked on your device indicates you should use these systems.



If you need more information on the collection, reuse, and recycling of this product, please contact your local or regional waste administration.

You can also contact DYMO for more information on the environmental performance of our products.