

User's Guide

DS-820W
DS-920DW

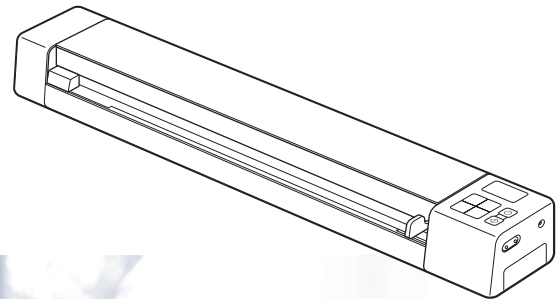

Using the documentation

Thank you for buying a Brother machine! Reading the documentation will help you make the most of your machine.

Symbols and conventions used in the documentation

The following symbols and conventions are used throughout the documentation.

IMPORTANT

IMPORTANT indicates a potentially hazardous situation which, if not avoided, may result in damage to property or loss of product functionality.

NOTE

Notes tell you how you should respond to a situation that may arise or give tips about how the operation works with other features.

Bold

Bold style identifies keys on the machine control panel or computer screen.

Italics

Italicized style emphasizes an important point or refers you to a related topic.

Courier New

Courier New font identifies the messages shown on the LCD of the machine.

NOTE

- For DSmobile 920DW users: this guide uses DSmobile 820W screen images, unless otherwise indicated.
 - If you are using a tablet running Windows[®], you can make your selections either by tapping the screen or by clicking with your mouse.
-

Trademarks

The Brother logo, Brother and DSmobile are registered trademarks of Brother Industries, Ltd.

Apple, Macintosh, Mac OS, iOS and App Store are trademarks of Apple Inc., registered in the United States and other countries.

Windows and Windows Vista are either registered trademarks or trademarks of Microsoft Corporation in the United States and / or other countries.

Wi-Fi is a registered trademark of the Wi-Fi Alliance.

Google Play and Android are trademarks of Google Inc.

Nuance, the Nuance logo and PaperPort are trademarks or registered trademarks of Nuance Communications, Inc. or its affiliates in the United States and / or other countries.

Any trade names and product names of companies appearing on Brother products, related documents and any other materials are all trademarks or registered trademarks of those respective companies.

Table of contents

1	General Information	1
	Scanner overview	1
	Control panel overview	3
	Items displayed on the LCD	5
	LCD messages	6
	Power button LED indications	6
	Checking the Wi-Fi® indicator	7
	Setting the Clock	8
	Using the auto power off function	8
	Installing the battery	9
	Charging battery	10
	Formatting an SD card	11
	Changing the scan resolution (DS-920DW only)	11
2	Document Specifications	12
	Acceptable documents	12
	Unacceptable documents	13
	Documents recommended for use with the Carrier Sheet	13
3	Scan Preparation	15
	Loading a document	15
	Loading the Carrier Sheet	16
	Important Carrier Sheet tips	17
4	Scan Using the Control Panel	18
	Scanning in SD mode	18
5	Scan Using Your Computer	19
	Installing the scanner driver and scanning software	19
	For Windows® users	19
	For Macintosh users	21
	Connecting your scanner to your computer in TWAIN Mode	23
	Choosing your scanning software	23
	Using DSmobileCapture (for Windows®)	24
	Changing DSmobileCapture scan settings (for Windows®)	27
	File settings	27
	Image settings	28
	Paper settings	29
	Preview settings	31
	Options settings	32
	Imprinter settings	33
	Information	34
	Using DSmobileCapture (for Macintosh)	35
	Changing DSmobileCapture scan settings (for Macintosh)	36
	Image settings	36

	File settings	38
	Paper settings	39
	Options settings	40
	Information	41
	Using Button Manager V2 (for Windows®)	42
	Scanning method	44
	Scan buttons in the Button Manager V2 Button Panel (for Windows®)	45
	Scan to an image	45
	Scan to BR-Docs	45
	Scan to an application	46
	Scan to an email	46
	Scan to a printer	47
	Scan to shared folder	47
	Scan to a FTP server	47
6	Wi-Fi® Connection	48
	Connecting in access point (AP) mode	48
7	Scan to the Cloud Server Using a Wireless Access Point (BOL Mode)	50
8	Access Scanned Images on the SD Card	51
	Using your web browser	51
	Setting a Wi-Fi® network password	51
	Using the USB connection between your scanner and computer	54
	Using ScanHub™ (Android™)	55
	Using ScanHub™ (iOS)	55
9	Changing Settings Using Your Browser	56
	Configuring Wi-Fi® settings in access point (AP) mode	56
	Configure network settings	56
	Reset network settings	57
10	Scanner Calibration	58
	Calibration using the control panel	58
	Calibration using software (for Windows®)	59
	Calibration using software (for Macintosh)	62
11	Scanner Maintenance	64
	Cleaning the outside of your scanner	64
	Cleaning the inside of your scanner	64
12	Troubleshooting	66
	Error messages and Error codes	66
	Troubleshooting	68

A Appendix A 75

Specifications75

- General75
- Scanner76
- Li-ion battery77
- Interfaces77
- Network77
- Computer requirements78

B Appendix B 79

Contacting Brother79

- Register your product79
- Frequently asked questions (FAQs)79
- For customer service80
- Technical support (for PageManager and BizCard)81

Basic functions

Storing scanned images

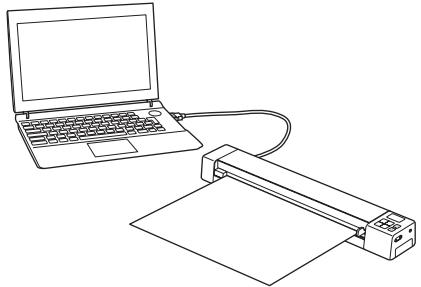
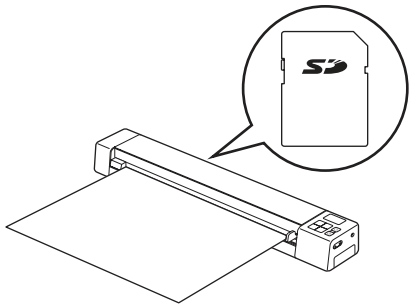
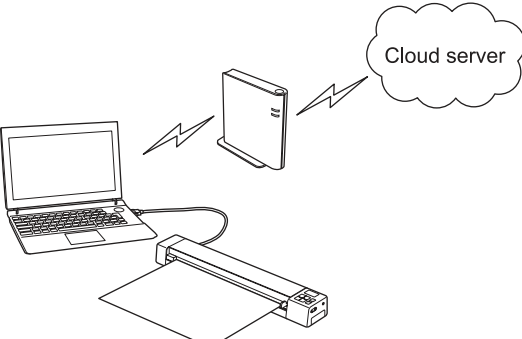
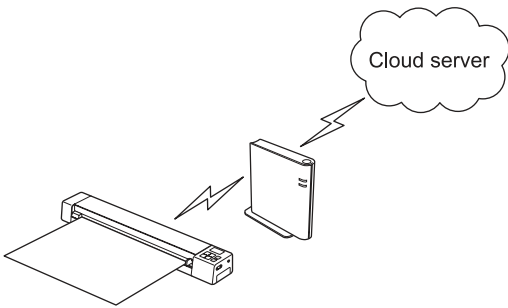
Scan to your computer ^{*1}	Scan to an SD Memory Card (SD card)
<p>You can store scanned images on your computer as long as the Micro USB Cable connects the scanner and the computer. For more information, see <i>Scan Using Your Computer</i> on page 19.</p> 	<p>You can store scanned images on the SD card included with your scanner. For more information, see <i>Scan Using the Control Panel</i> on page 18.</p> 
Scan to cloud server ^{*2,3}	
<p>You can store scanned images in BR-Docs (Brother Online storage) using the Button Manager V2 Button Panel. For more information, see the <i>Button Manager V2 User's Guide</i>.</p> 	<p>You can store scanned images in BR-Docs using your scanner's control panel. You must first connect your scanner to the Internet via an access point. For more information, see <i>Scan to the Cloud Server Using a Wireless Access Point (BOL Mode)</i> on page 50.</p> 

*1: This function is not available while using the Wi-Fi® connection.

*2: To use this function, you need a Brother Online account.

*3: To use this function, you need an Internet connection.

Accessing scanned images stored on the SD card

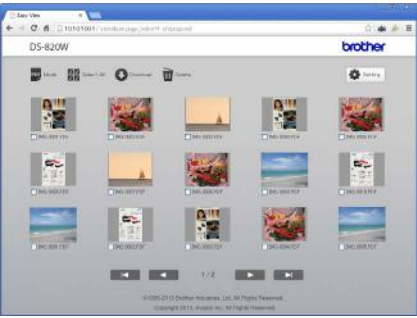
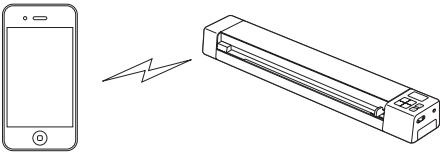
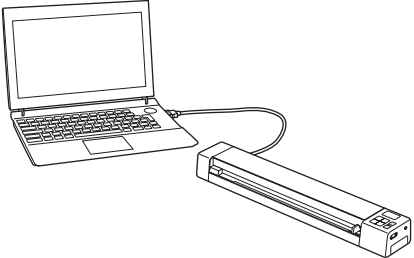
View in the browser	View on an Android™ or iOS mobile device	View on your computer via the USB connection
<p>Access scanned images stored on the SD card via the web browser of a wireless LAN tablet or your computer. For more information, see <i>Using your web browser</i> on page 51.</p> 	<p>Access scanned images stored on the SD card via ScanHub™. For more information, see <i>Using ScanHub™ (Android™)</i> on page 55 or <i>Using ScanHub™ (iOS)</i> on page 55.</p> 	<p>Access and view scanned images stored on the SD card from your computer when it is connected to your scanner via the supplied Micro USB Cable. For more information, see <i>Using the USB connection between your scanner and computer</i> on page 54.</p> 

Scanner overview

Front

DS-820W

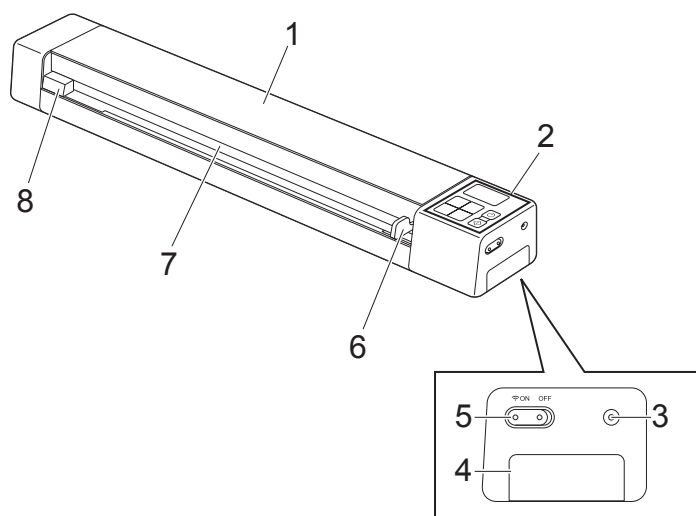

DS-920DW

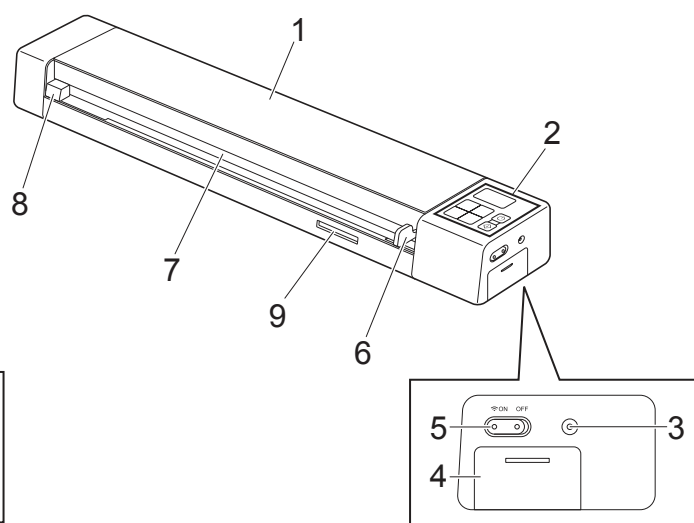

- 1 Top cover
- 2 Control panel
- 3 Reset button
- 4 Battery compartment
- 5 Wi-Fi® (ON / OFF) switch

NOTE

When you do not use the Wi-Fi® function, set the Wi-Fi® switch to **OFF**. If you leave the switch in the **ON** position, the battery will be consumed faster.

- 6 Document guide
- 7 Feeder slot
- 8 Left edge
- 9 SD card slot

Rear

DS-820W

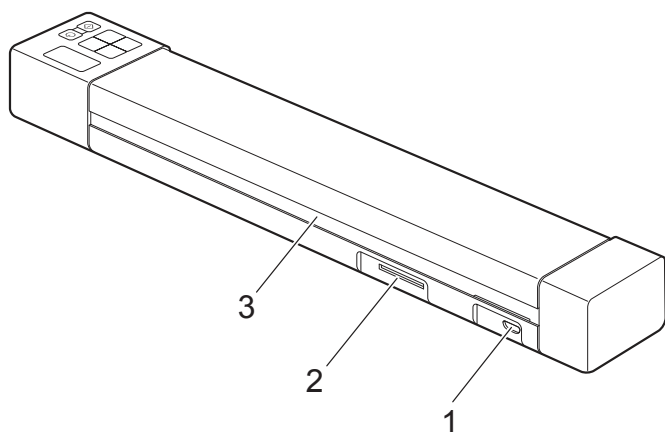

DS-920DW

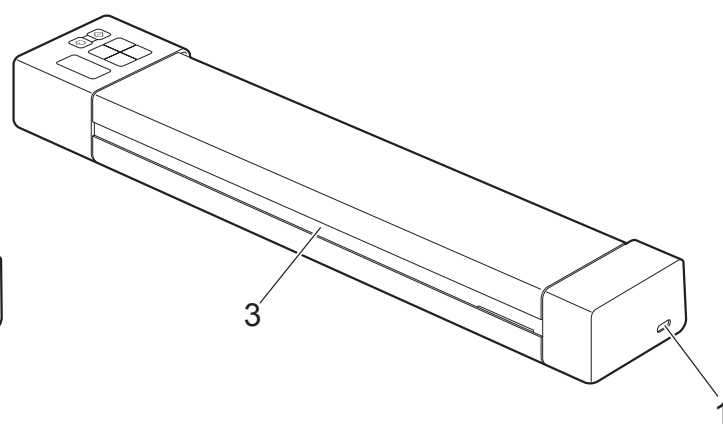

- 1 Micro USB port
- 2 SD card slot
- 3 Paper ejection slot

Control panel overview

DS-820W

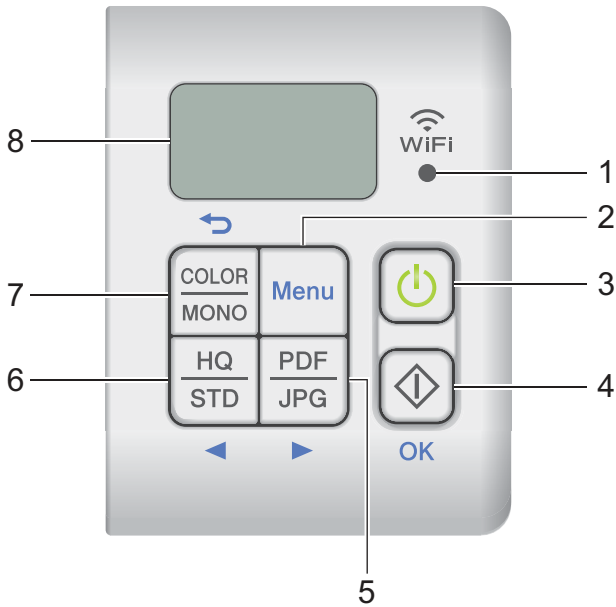

DS-920DW

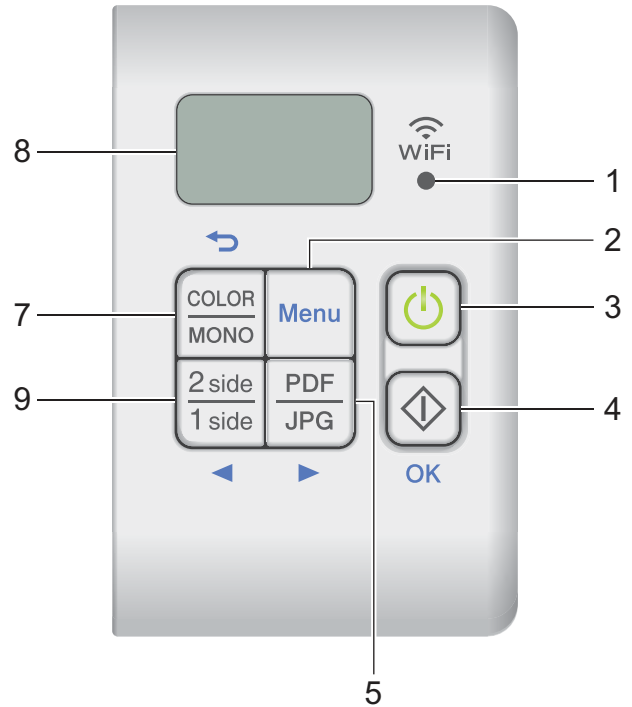

1 Wi-Fi® indicator

Indicates the status of the Wi-Fi® connection.

2 Menu button

Press to configure the menu settings.

3 Power button

- Press to turn on the scanner.
- Press and hold to turn off the scanner.

4 Start / OK button

- Press to confirm a selected item.
- For Windows®
Press to start scanning when using Button Manager V2.
For more information, see *Using Button Manager V2 (for Windows®)* on page 42.
- For Macintosh
Press to start scanning when using DSmobileCapture.
For more information, see *Using DSmobileCapture (for Macintosh)* on page 35.

5 PDF / JPG (▶) button

- Press to change the scanning file format (PDF or JPEG).
- Press to scroll through the menu and option items.

6 HQ / STD (◀) button

- Press to change the resolution. **HQ** is 600 dpi and **STD** is 300 dpi.
- Press to scroll through the menu and option items.

7 COLOR / MONO (↔) button

- Press to change the scan mode (color or mono [black and white]).
- Press to return to the previous screen.

8 Liquid Crystal Display (LCD)

Displays messages to help you set up and use your scanner.

9 2 side / 1 side (◀) button

- Press to change the scan mode (2 side scan or 1 side scan).
- Press to scroll through the menu and option items.

Items displayed on the LCD

DS-820W

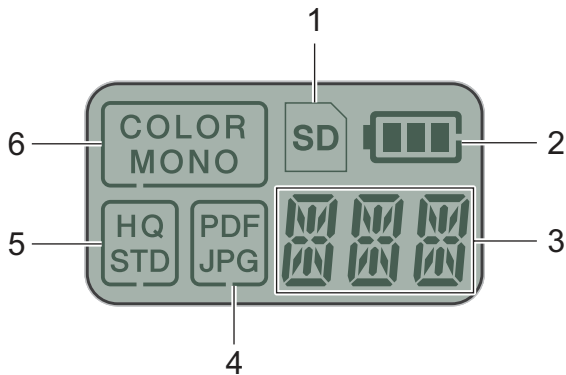

DS-920DW

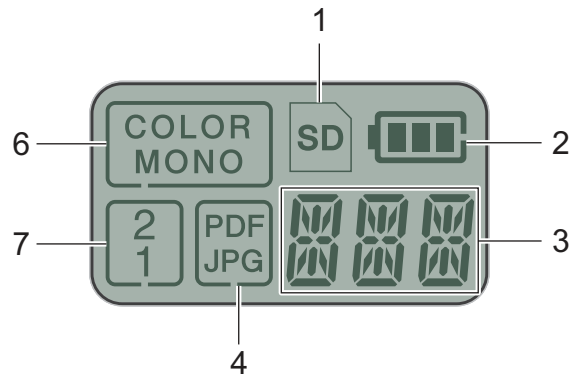

1 SD

Appears when the SD card is inserted into the scanner's SD card slot.

2 Remaining battery power

3 The selected menu or the current status appears here.

For more information about the messages displayed on the LCD, see *LCD messages* on page 6.

4 PDF / JPG

Displays the scanning file format (PDF or JPEG).

5 HQ / STD (DS-820W only)

Press to change the resolution. **HQ** is 600 dpi and **STD** is 300 dpi.

6 COLOR / MONO

Displays the scan mode (color or mono [black and white]).

7 2 / 1 (DS-920DW only)





Displays the scan mode (2 side (double-sided) scan or 1 side (single-side) scan).

LCD messages

1







Message	Machine Status
PC	The machine is connected to your computer in TWAIN mode.
SD	The machine is in SD mode (Mass-storage mode). For more information, see <i>Scanning in SD mode</i> on page 18.
DPI	(DS-920DW only) The machine displays the menu to change the resolution. For more information, see <i>Changing the scan resolution (DS-920DW only)</i> on page 11.
BRD	The machine is in BR-Docs mode. For more information, see <i>Scan to the Cloud Server Using a Wireless Access Point (BOL Mode)</i> on page 50.
FMT	The machine displays the menu to format an SD card. For more information, see <i>Formatting an SD card</i> on page 11.
TME	The machine displays the menu to set its clock. For more information, see <i>Setting the Clock</i> on page 8.
CAL	The machine displays the calibration menu. For more information, see <i>Calibration using the control panel</i> on page 58.
PWR	The machine displays the menu to use the auto power off function. For more information, see <i>Using the auto power off function</i> on page 8.
----	The machine is not connected to your computer and there is no SD card inserted in it.

Power button LED indications

LED indication	Machine Status
No light 	The machine is not connected to your computer or the Li-ion battery is not installed.
Green light 	The machine is ready to scan or is charging the battery.
Blinking green 	The machine is scanning a document.
Rapidly blinking red 	Some error has occurred. The top cover is open, or a document is jammed.

Checking the Wi-Fi® indicator

1

Wi-Fi® indicator	Wi-Fi® status
No light 	The Wi-Fi® switch is set to OFF .
Lit (Red) 	The Wi-Fi® switch is set to ON and the scanner is starting up a Wi-Fi® connection. It will take about 40 seconds to make the Wi-Fi® connection.
Lit (Blue) 	A Wi-Fi® connection has been made [in access point (AP) mode]. For more information, see <i>Connecting in access point (AP) mode</i> on page 48.
Blinking (Blue) 	The scanner is searching for an access point.
Lit (Orange) 	Connection to an access point has been made.
Blinking (Orange) 	Your scanner is transferring scanned images to BR-Docs . For more information, see <i>Scan to the Cloud Server Using a Wireless Access Point (BOL Mode)</i> on page 50.
Slow blinking (Red) 	Connection to BR-Docs has failed.

NOTE

When you are not using the Wi-Fi® function, set the Wi-Fi® switch to **OFF**. If you leave the switch in the **ON** position, the battery will be consumed faster.

Setting the Clock

Before using your scanner, set the scanner clock to the correct time.

- 1 Turn on your scanner.
- 2 On the scanner's control panel, press **Menu**.
- 3 Press ◀ or ▶ until **TME** is displayed on the LCD.
- 4 Press **Start / OK**.
- 5 Press ◀ or ▶ to set year.
- 6 Press **Start / OK** to confirm the year.

NOTE

To return to the previous screen, press the **COLOR / MONO** (↔) button.

- 7 Repeat steps 5 and 6 to set month, day, hour (24-hour format) and minute.
- 8 After setting the minute, the LCD displays **OK**, indicating that the clock is set.

Using the auto power off function

You can turn your scanner off automatically to save power. The scanner will power off after five minutes of inactivity.

NOTE

When the Wi-Fi® switch is set to **ON**, this function is disabled.

- 1 Turn on your scanner.
- 2 On the scanner's control panel, press **Menu**.
- 3 Press ◀ or ▶ until **PWR** is displayed on the LCD.
- 4 Press **Start / OK**.
- 5 Do one of the following:
 - To enable the auto power off function, press ◀ or ▶ to select **YES**.
 - To disable the auto power off function, press ◀ or ▶ to select **NO**.
- 6 Press **Start / OK**.
- 7 The LCD displays **OK**, indicating that auto power off has been set.

Installing the battery

Install the supplied Li-ion Battery into the end of your scanner, as shown in the illustration.

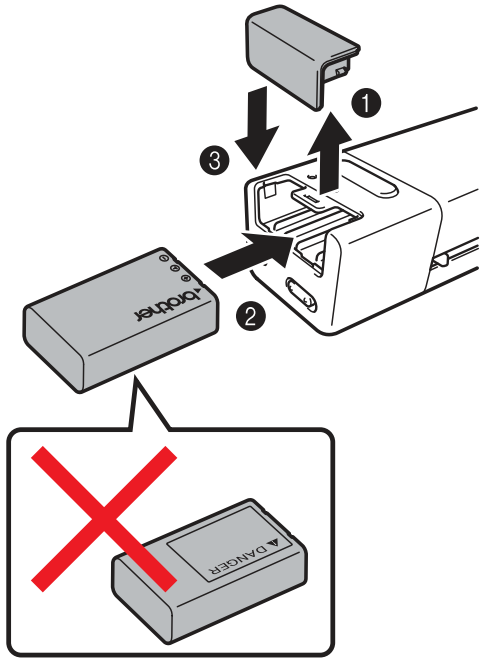

DS-820W



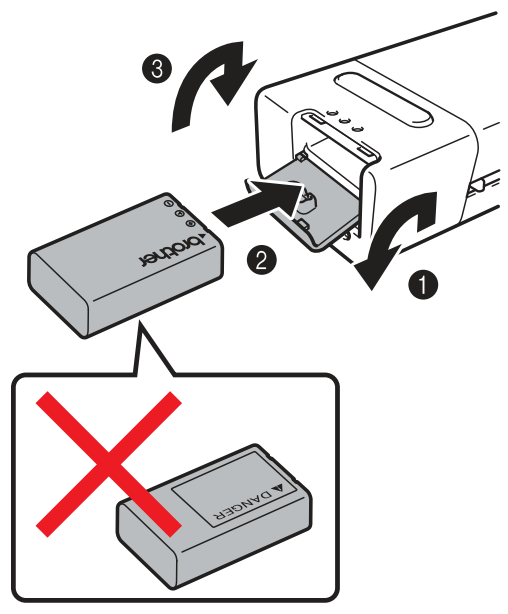

DS-920DW





Charging battery

- 1 Make sure that your computer is ON.
- 2 Connect the supplied Micro USB Cable to the micro USB port  on your scanner.
- 3 Connect the cable to your computer. The battery starts charging automatically.
- 4 The **Power** button  lights up green while the battery is charging, and goes off when charging is complete.

NOTE

- When charging the battery, press and hold the **Power** button  to turn off your scanner. You can charge the battery with the power either on or off, but charging takes more time than when the scanner is off.
- When charging the battery with the power on, slide the Wi-Fi® switch  to **OFF**.
- When the scanner is turned on, the battery level is displayed on the LCD panel.

Battery icon	Power level
	Full
	Half full
	Low

- If you do not use the scanner for a long period, charge the battery fully at least once every six months to prevent battery capacity deterioration.
- If you do not use the scanner for a long period, remove the battery from the scanner, and store the battery in a cool, dry place at a consistent temperature.

Formatting an SD card

When you purchase your own SD card, you must format the SD card before using it.

NOTE

Before formatting an SD card, make sure if there is no important data on it. When you format an SD card that was previously used with other devices, all of its data will be deleted.

- 1 Insert the SD card into the SD card slot.
- 2 Turn on your scanner.
- 3 Make sure that **SD** appears on the LCD display.
- 4 On the scanner's control panel, press **Menu**.
- 5 Press ◀ or ▶ until **FMT** is displayed on the LCD.
- 6 Press **Start / OK**.
- 7 Do one of the following:
 - To format the SD card, press ◀ or ▶ to select **YES**, and then press **Start / OK**.
The SD icon and **FMT** in the LCD display will blink, and the scanner will begin to format the SD card. When the LCD display **OK**, formatting is complete.
 - To cancel formatting, press ◀ or ▶ to select **NO**, and then press **Start / OK**.

Changing the scan resolution (DS-920DW only)

NOTE

For DS-820W: change the resolution using your scanner's **HQ / STD (◀)** button.

- 1 Turn on your scanner.
- 2 On the scanner's control panel, press **Menu**.
- 3 Press ◀ or ▶ until **DPI** is displayed on the LCD.
- 4 Press **Start / OK**.
- 5 Press ◀ or ▶ to select **600 (600dpi)** or **300 (300dpi)**.
- 6 Press **Start / OK**.
- 7 The LCD displays **OK**, indicating that resolution has been set.

2

Document Specifications

Acceptable documents

2

Standard Paper	Length	1 side scan 3.5 in. to 32 in. (90 mm to 812.8 mm) 2 side scan (DS-920DW only) 3.5 in. to 16 in. (90 mm to 406.4 mm)	
	Width	2.2 in. to 8.5 in. (55 mm to 215.9 mm)	
	Weight	16 lb to 28 lb (60 g/m ² to 105 g/m ²) To scan thinner document, use the Carrier Sheet (see <i>Loading the Carrier Sheet</i> on page 16).	
	Maximum Number of Pages	1 page (1 sheet)	
	Standard Paper Size	A4 A5 A6 A7 A8 B5 B6 B7 B8 Legal Letter	8.3 × 11.7 in. (210 × 297 mm) 5.8 × 8.3 in. (148 × 210 mm) 4.1 × 5.8 in. (105 × 148 mm) 2.9 × 4.1 in. (74 × 105 mm) 2.0 × 2.9 in. (52 × 74 mm) 7.2 × 10.1 in. (182 × 257 mm) 5.0 × 7.2 in. (128 × 182 mm) 3.6 × 5.0 in. (91 × 128 mm) 2.5 × 3.6 in. (64 × 91 mm) 8.5 × 14 in. (215.9 × 355.6 mm) 8.5 × 11 in. (215.9 × 279.4 mm)

Plastic Cards (DS-820W: non-embossed cards only)	Length	1.57 in. to 3.4 in. (40 mm to 86 mm)	
	Width	1.57 in. to 3.4 in. (40 mm to 86 mm)	
	Standard Size (ISO)	3.37 × 2.13 × 0.03 in. (85.6 × 54.0 × 0.76 mm)	
	Material	Plastic (PET)	
	Type	Plastic card such as a driver's license or an insurance card	
	Thickness	Less than 0.031 in. (0.8 mm)	
	Maximum Number of Pages	1 page (1 sheet)	

Receipts	Length	1 side scan 3.5 in. to 32 in. (90 mm to 812.8 mm) 2 side scan (DS-920DW only) 3.5 in. to 16 in. (90 mm to 406.4 mm)	
	Width	2.2 in. to 8.5 in. (55 mm to 215.9 mm)	
	Thickness	More than 0.016 in. (0.04 mm)	
	Maximum Number of Pages	1 page (1 sheet)	

Unacceptable documents

- Documents with paper clips or staples
- Documents with wet ink
- Fabrics, metallic sheets, overhead projector sheets
- Glossy or mirrored media
- Embossed plastic cards
- Documents that exceed recommended thicknesses

Documents recommended for use with the Carrier Sheet

Use the supplied Carrier Sheet when you scan the following:

- Documents with a carbon sheet attached on the back
- Documents written in pencil
- Documents narrower than 2.2 in. (55 mm) wide
- Documents shorter than 3.5 in. (90 mm) long
- Documents of uneven thickness, such as envelopes
- Documents with large wrinkles or curls
- Bent or damaged documents
- Documents that use tracing paper
- Documents that use coated paper
- Photographs (photographic paper)
- Documents printed on perforated paper
- Documents printed on unusually-shaped paper (not square or rectangle)
- Documents with photos, notes, or stickers affixed to them
- Documents that use carbonless paper
- Documents that use loose-leaf paper or any paper with holes in it
- Photographic negatives

For more information about using the Carrier Sheet when scanning, see *Loading the Carrier Sheet* on page 16.

CAUTION

To avoid cutting yourself, do not slide or scrape your hand or fingers along the edges of the Carrier Sheet.

IMPORTANT

- Do not place the Carrier Sheet in direct sunlight or in an area subject to high temperatures and high humidity, or the Carrier Sheet may warp.
 - Do not place large or heavy objects on the Carrier Sheet when it is lying flat.
 - Do not bend or pull the Carrier Sheet. If it becomes damaged, it may not be acceptable for scanning, and should not be used.
-

Loading a document

IMPORTANT

- Insert only one page into the scanner at a time. Insert the next page only after the first one is completely scanned. Inserting more than one page at a time may cause your scanner to malfunction.
- DO NOT pull on the document while it is feeding.
- DO NOT use paper that is curled, wrinkled, folded, ripped, stapled, paper clipped, pasted, or taped.
- DO NOT try to scan cardboard or fabric.

NOTE

- Make sure there is enough space behind the paper ejection slot. The scanned document will be ejected from the rear of the scanner.
- Make sure documents that have ink or correction fluid on them are completely dry.
- Certain types of plastic cards may be scratched when scanned. To prevent damage to the card, we recommended using the Carrier Sheet. For more information, see *Loading the Carrier Sheet* on page 16.

- 1 Set your document ① face up in the feeder slot ② and align the left edge of the page with the left edge of the feeder slot ③.
To scan a plastic card ①, set the card top edge first into the feeder slot ② and align the left edge of the card with the left edge of the feeder slot ③.
For **DS-920DW**: When you perform duplex scanning, insert the first page face up into the feeder slot.
- 2 Slide the document guide ④ until it touches the right side of the document.
- 3 Gently insert the document until you feel its top edge touch the inside of the scanner.

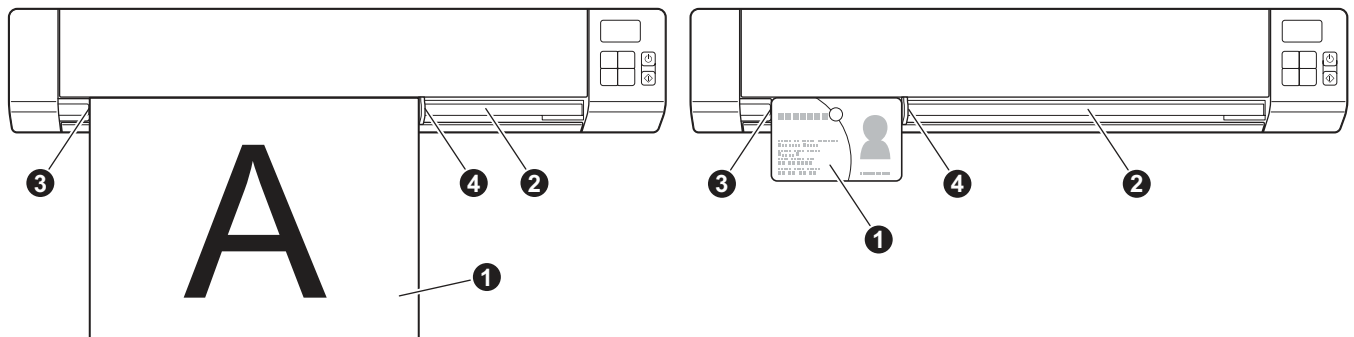

NOTE

If you insert a document while SD is displayed on the LCD, scanning begins automatically.

Loading the Carrier Sheet

NOTE

Make sure documents that have ink or correction fluid on them are completely dry.

- 1 Set the document you want to scan in the left corner of the Carrier Sheet and align the top of the document with the top left corner of the Carrier Sheet.

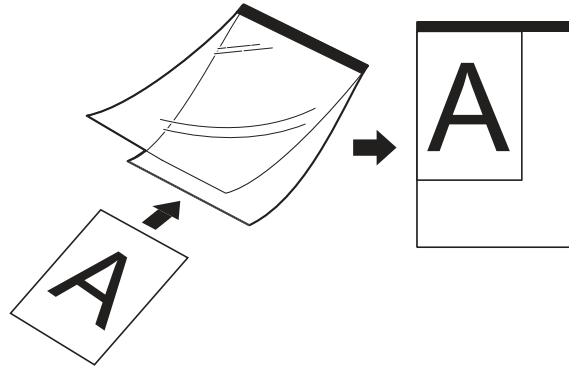

- 2 Set the Carrier Sheet ①, document face up, with the black edge first in the feeder slot ② and align the left edge of the Carrier Sheet with the left edge of the feeder slot ③.
For **DS-920DW**: When you perform duplex scanning, insert the first page face up into the feeder slot.
- 3 Slide the document guide ④ against the right side of the Carrier Sheet.
- 4 Gently insert the Carrier Sheet until you feel its top edge touch the inside of the scanner.

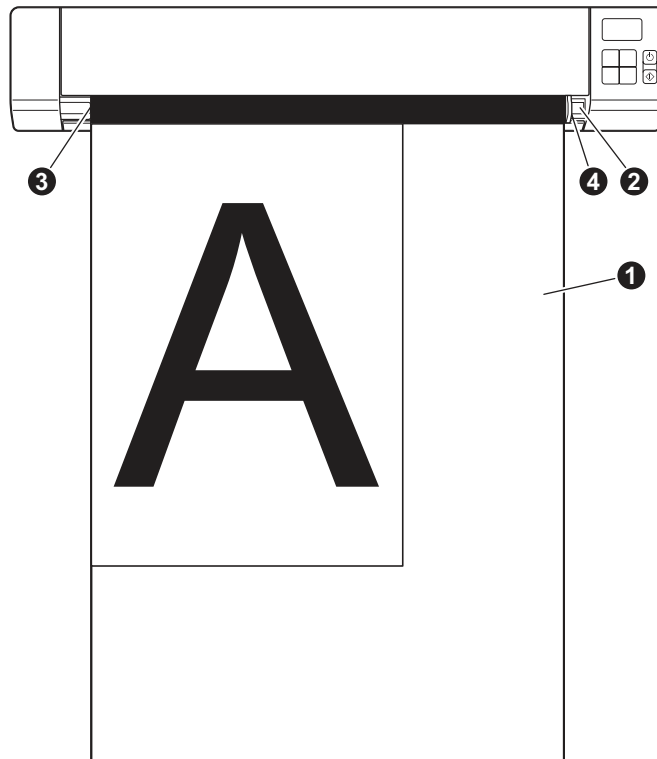

Important Carrier Sheet tips

- To avoid document jams, do not load the Carrier Sheet upside down. For more information, see *Loading the Carrier Sheet* on page 16.
- To avoid document jams, do not put several small documents into the Carrier Sheet at the same time. Insert only one document into the Carrier Sheet at a time.
- Do not write on the Carrier Sheet, as the writing may be seen in scanned documents. If the Carrier Sheet becomes dirty, wipe it with a dry cloth.
- Do not leave documents in the Carrier Sheet for extended periods of time, as the printing on the documents may bleed through onto the Carrier Sheet.

4

Scan Using the Control Panel

Scanning in SD mode

- 1 Insert the SD card into the SD card slot.

DS-820W

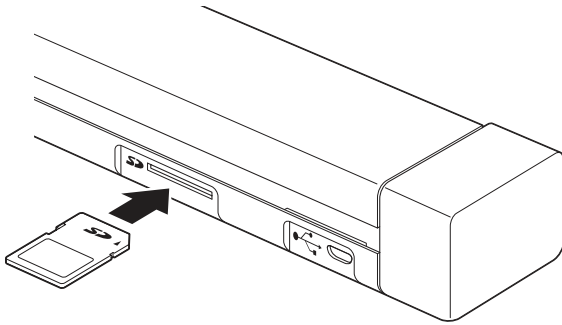

DS-920DW

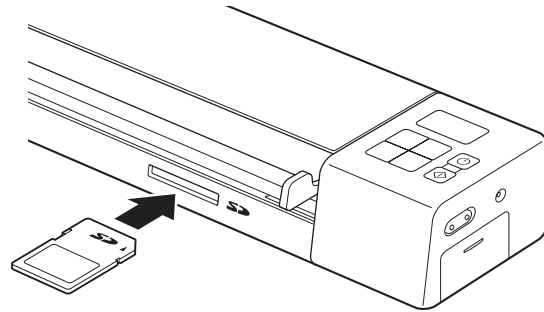

NOTE

When you use a purchased SD card, you must format the SD card first. To format the SD card on your scanner, see *Formatting an SD card* on page 11.

- 2 Turn on your scanner.
- 3 Make sure that **SD** appears on the LCD display.
- 4 If necessary, adjust the scanning settings by pressing the **COLOR / MONO**, **PDF / JPG** and **HQ / STD** (**2 side / 1 side**) buttons on the control panel.
- 5 Insert your document.
- 6 Your scanner starts scanning automatically.
The **Power** button LED blinks green and **SD** blinks on the LCD.
- 7 The scanned image is stored on the SD card.
Check the scan result just in case.

NOTE

To access the scanned images on the SD card, see *Access Scanned Images on the SD Card* on page 51.

5

Scan Using Your Computer

Installing the scanner driver and scanning software

For Windows® users

NOTE

- Make sure that your computer is ON and you are logged on with Administrator rights.
- DO NOT connect the Micro USB Cable yet.
- If your computer does not have a DVD-ROM drive, the supplied DVD-ROM does not contain drivers for your operating system, or you want to download manuals and utilities, visit your model page at <http://solutions.brother.com/>.

- 1 Insert the DVD-ROM.
- 2 When the **Setup** screen appears, click **Install Scanner Driver** and follow the on-screen instructions.



NOTE

- If the Brother screen does not appear automatically, go to **My Computer (Computer)**, double-click the CD-ROM icon, and then double-click **AutoRun.exe**.
- When you install the scanner driver, **DSmobileCapture** (a scanning application) will be installed at the same time. For more information on using DSmobileCapture, see *Using DSmobileCapture (for Windows®)* on page 24.

- 3 Click Additional Applications to install any of these applications during setup.
- **Button Manager V2**: document scanning and storing (in specified destinations)
 - **PaperPort™ 12SE**: document scanning, editing and management
 - **Presto! BizCard 6**: business card scanning, editing and management
 - **BR-Receipts**: receipt scanning, editing and management



NOTE

- To register your product and download **BR-Receipts**, click **Download BR-Receipts** to access the Brother Online site at <http://www.brother.com/product/brotheronline/>.
- For more information on which scanning application will work best for you, see *Choosing your scanning software* on page 23.

For Macintosh users

NOTE

- Make sure that your computer is ON and you are logged on with Administrator rights.
- DO NOT connect the Micro USB Cable yet.
- If your computer does not have a DVD-ROM drive, the supplied DVD-ROM does not contain drivers for your operating system, or you want to download manuals and utilities, visit your model page at <http://solutions.brother.com/>.

- 1 Insert the DVD-ROM.
- 2 Double-click on the DVD icon, and then double-click **DS-820W (DS-920DW)**.
- 3 Double-click on **Brother DS-820W (DS-920DW)** and follow the on-screen instructions to install the scanner driver.

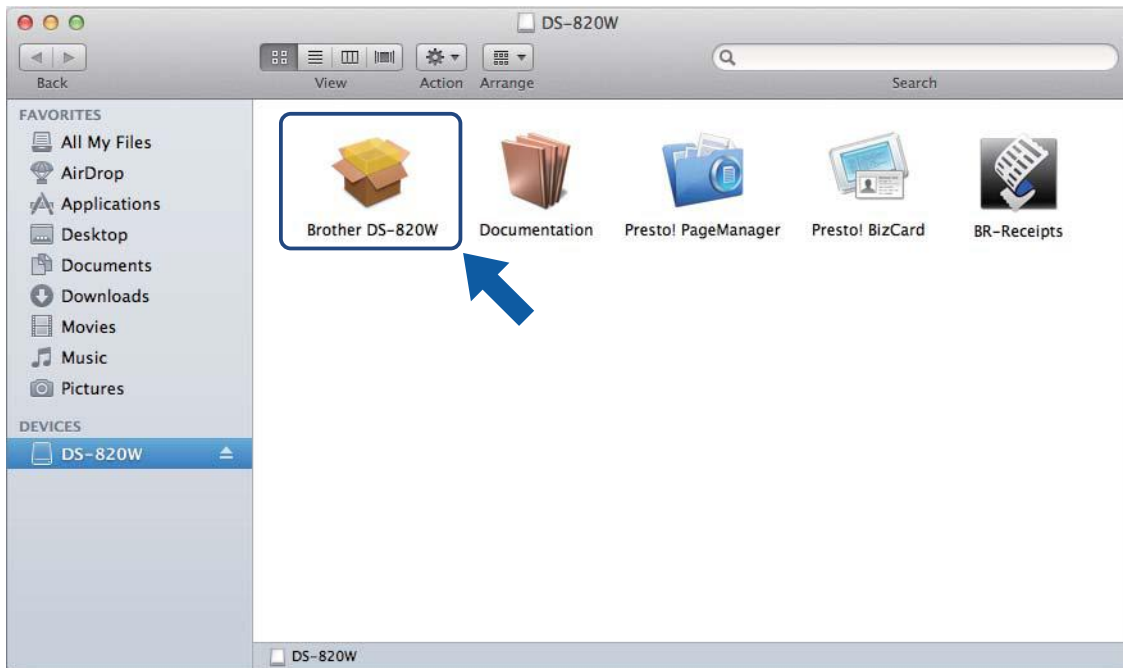

NOTE

When you install the scanner driver, **DScapture** (a scanning application) will be installed at the same time. For more information on using DScapture, see *Using DScapture (for Macintosh)* on page 35.

- 4 Click one of these folders to install the application during setup.
 - **Presto! PageManager 9**: document scanning, editing and management
 - **Presto! BizCard 6**: business card scanning, editing and management
 - **BR-Receipts**: receipt scanning, editing and management

NOTE

- Clicking **Presto! PageManager** or **Presto! BizCard** will bring you to NewSoft Technology Corporation's website. Download the application from this website.
 - To register your product and download **BR-Receipts**, double-click **BR-Receipts** to access the Brother Online site at <http://www.brother.com/product/brotheronline/>.
 - For more information on which scanning application will work best for you, see *Choosing your scanning software* on page 23.
-

Connecting your scanner to your computer in TWAIN Mode

Before scanning a document using the scanning software, select TWAIN Mode on your computer.

- 1 Turn on your scanner.
- 2 Connect the Micro USB Cable to the Micro USB port on your scanner. Connect the cable to your computer.
- 3 Press the **Start / OK** button on the scanner to display **PC** on the LCD.



Choosing your scanning software

After downloading the scanner drivers, select a scanning software application for saving scanned images to your computer. Brother has supplied several options for you on the DVD-ROM; use this table to help determine which of the included scanning applications will work best for you:

Software	Function	For more information
DSmobileCapture	Document scanning, browsing and filing	For Windows®: See <i>Using DSmobileCapture (for Windows®)</i> on page 24. For Macintosh: See <i>Using DSmobileCapture (for Macintosh)</i> on page 35.
Button Manager V2 (Windows® only)	Document scanning and storing (in specified destinations)	See the software's user instructions or <i>Using Button Manager V2 (for Windows®)</i> on page 42.
Nuance PaperPort™ 12SE (Windows® only)	Document scanning, OCR scanning, editing and management	See the software's user instructions.
Presto! PageManager 9 (Macintosh only)	Document scanning, OCR scanning, editing and management	See the software's user instructions.
Presto! BizCard 6	Business card scanning, editing and management	See the Presto! BizCard User's Manual which will be downloaded onto your computer when you download the software.
BR-Receipts	Receipt scanning and management	See the software's user instructions.

NOTE

- Clicking **Presto! PageManager** or **Presto! BizCard** will bring you to NewSoft Technology Corporation's website. Download the application from this website.
- To register your product and download **BR-Receipts**, double-click **BR-Receipts** to access the Brother Online site at <http://www.brother.com/product/brotheronline/>.

Using DSmobileCapture (for Windows®)

- 1 Connect the supplied Micro USB Cable to the Micro USB port on your scanner. Connect the cable to your computer.
- 2 Double-click the **DSmobileCapture** shortcut  on your desktop.
- 3 The **Select Scanner Model** dialog box appears. Select **TWAIN** under **Driver Type** and select **Brother DS-820W** under **Scanner Model**, and then click **OK**.

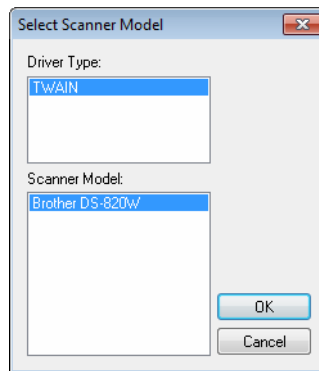

- 4 **DSmobileCapture** launches.

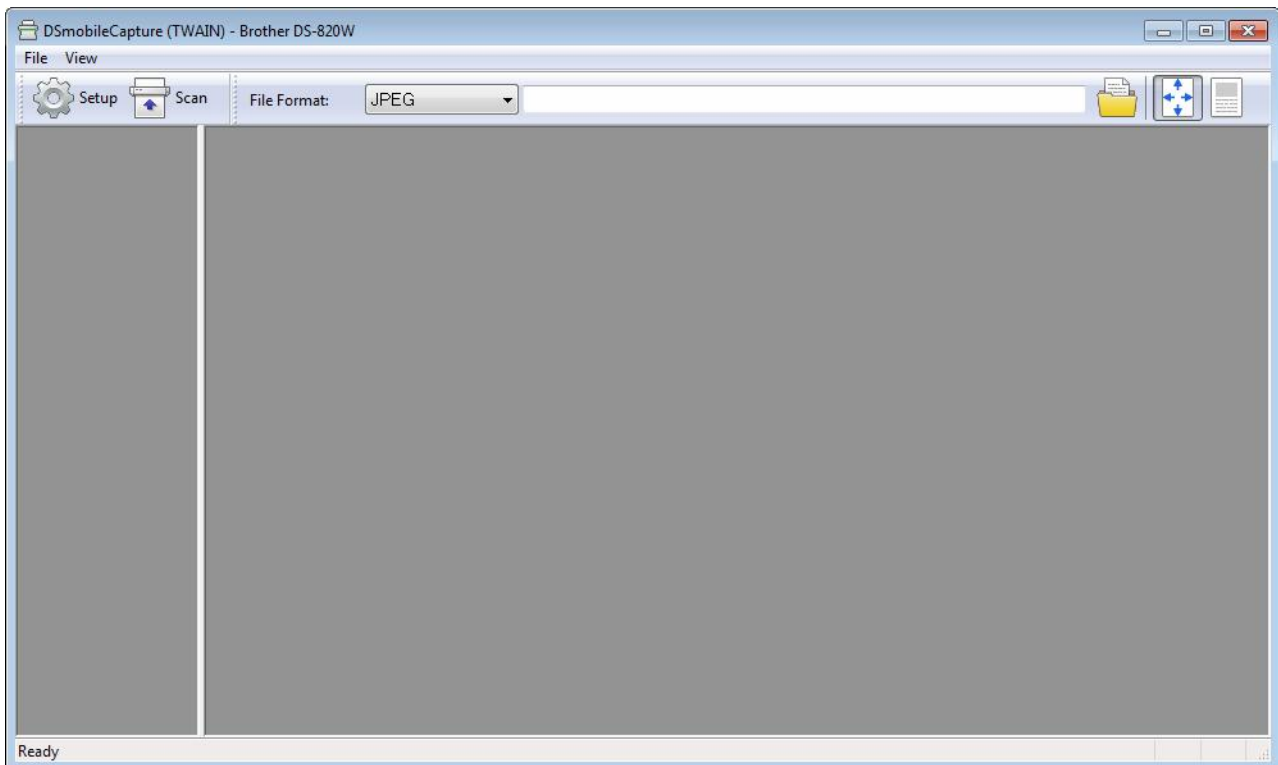

- 5 Change the scanning settings, if needed.
For more information on changing settings, see *Changing DSmobileCapture scan settings (for Windows®)* on page 27.
- 6 Insert a document into your scanner.
- 7 Click **Scan** . Your scanner starts scanning.

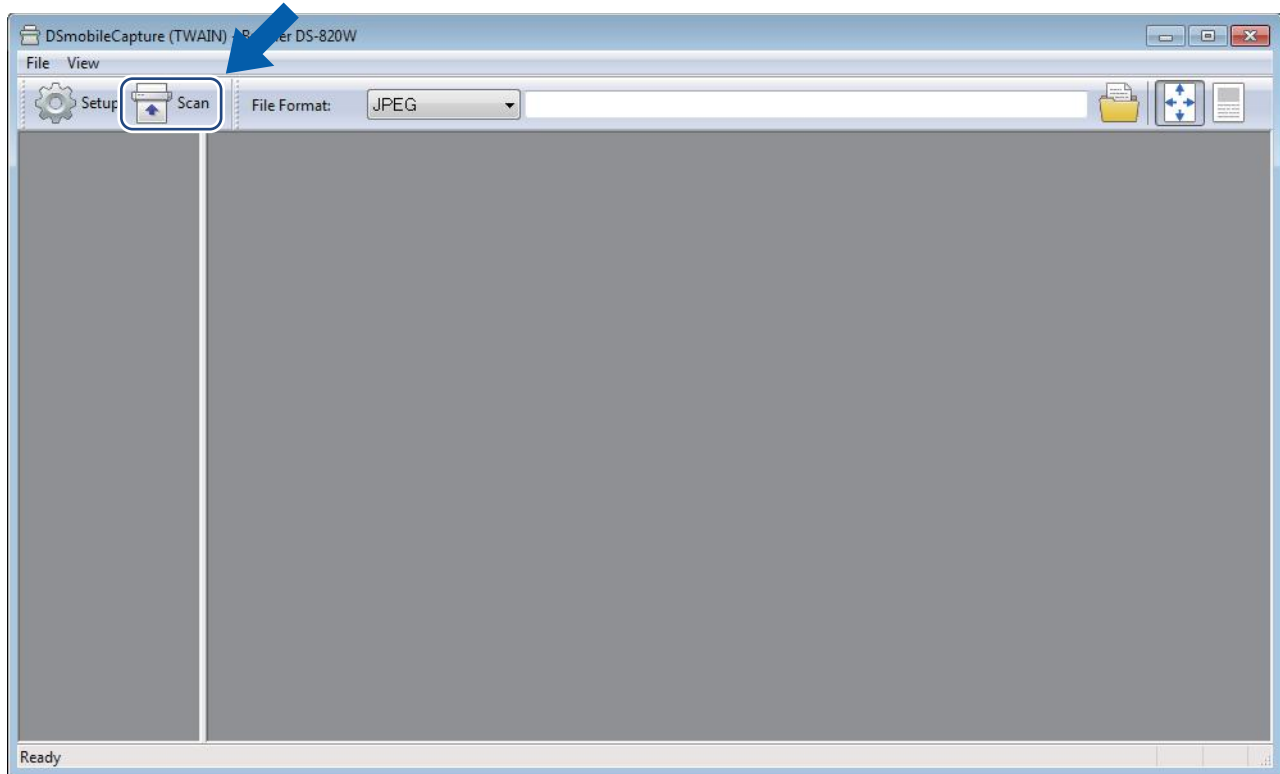

A thumbnail of the scanned image appears in the DSmobileCapture screen and the scanned image will be saved in the directory you specified in step 5.
Check the scan result just in case.

- 8 For continuous scanning, insert the next document into the scanner while **Waiting next job...** screen appears. When the document is inserted, scanning will start automatically.
To stop the continuous scanning, click **Cancel** on **Waiting next job...** screen.

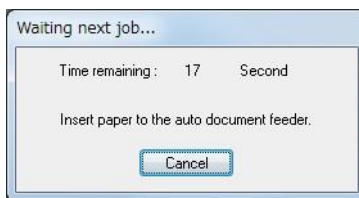

NOTE

- To change the time delay when waiting for the next job, see *Paper settings* on page 29.
 - To save multiple documents as one file, choose **Multi-page PDF** or **Multi-page TIFF** from the **File Format** drop-down list.
-

Changing DSmobileCapture scan settings (for Windows®)

File settings

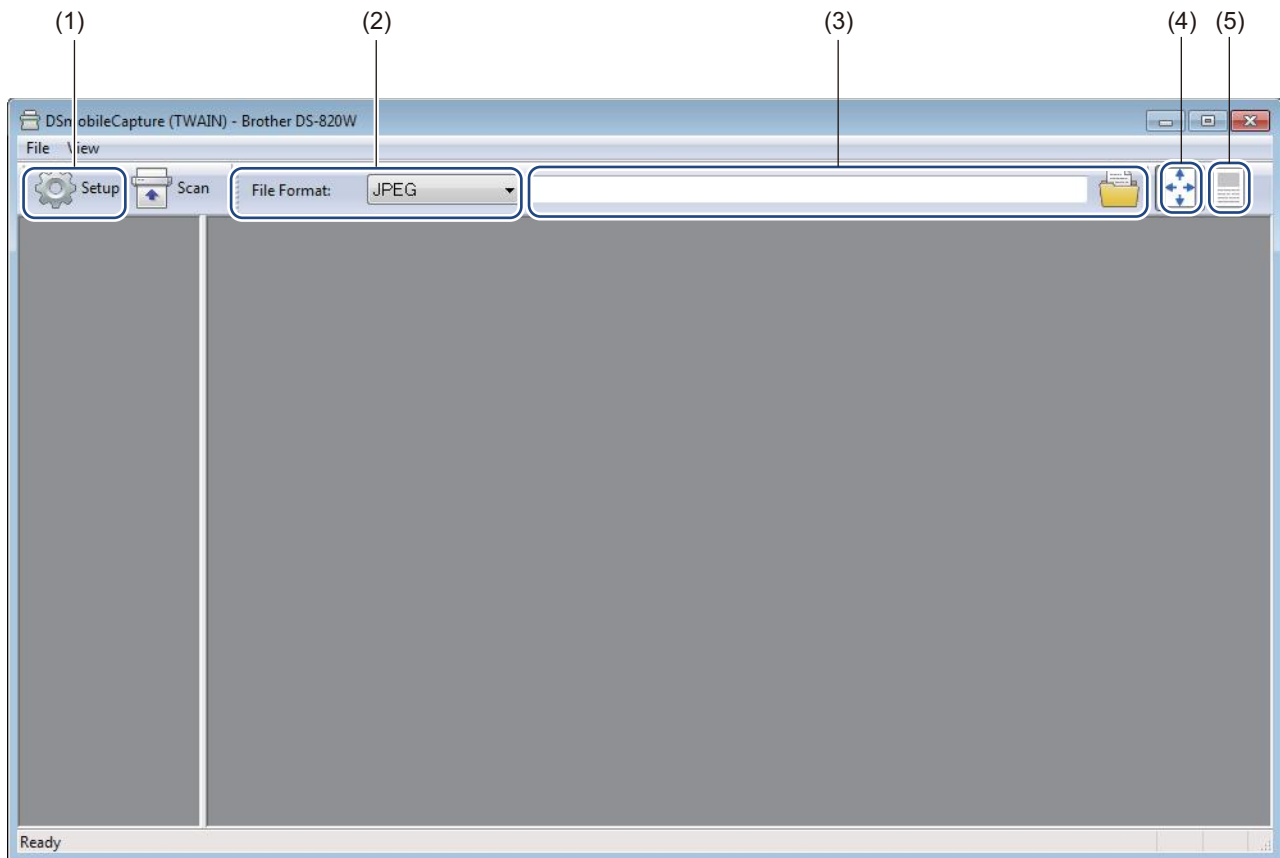

(1)	Setup	Change scanner properties.
(2)	File Format	Change the file format. Select the format you want from the drop-down list.
(3)	Path	Specify the directory where you want to save scanned images.
(4)	Fit Page	You can view and size the scanned image. You cannot use Fit Page when PDF or Multi-page PDF is chosen in File Format .
(5)	Actual Size (100%)	You can view the scanned image in Actual Size (100%) . You cannot use Actual Size (100%) when PDF or Multi-page PDF is chosen in File Format .

Image settings

Click **Setup** , and then click the **Image** tab to choose image type and to set basic scan settings.

NOTE

This image is from the DS-920DW.

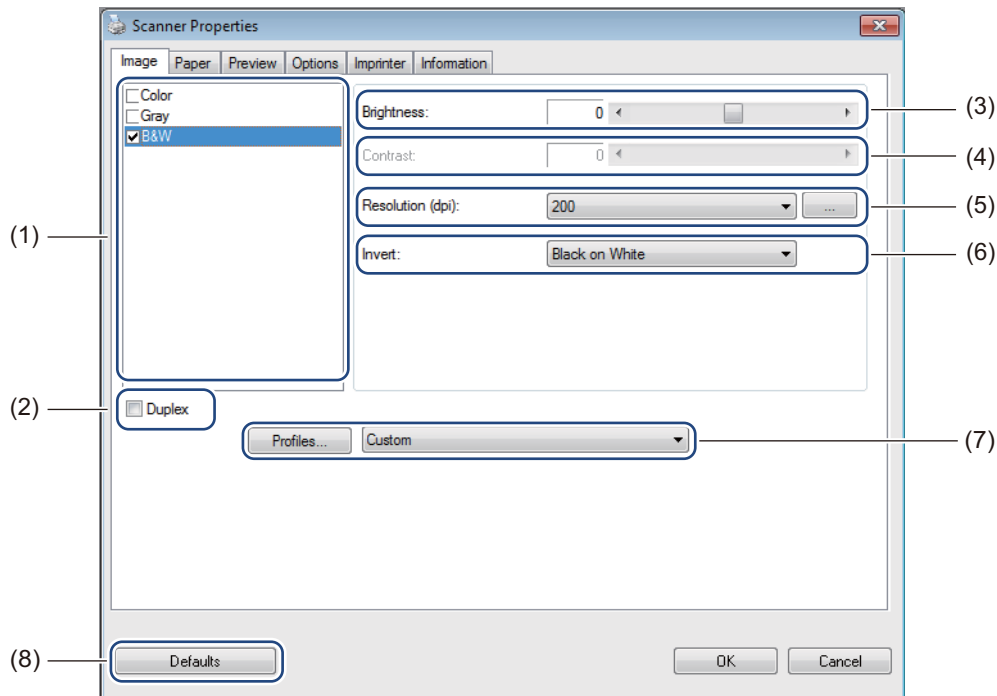

(1)	Image Selection Box	Choose the type of document you want to scan.
(2)	Duplex	(DS-920DW only) Select the Duplex check box to perform Duplex (2 side) scanning.
(3)	Brightness	Adjusts the lightness or darkness of an image. The range is from -100 to +100 . The factory default is 0 .
(4)	Contrast	Adjusts the range between the darkest and the lightest shades in the image. The range is from -100 to +100 . The factory default is 0 .
(5)	Resolution	Determine the quality of the scanned image. The factory default is 200 dpi .
(6)	Invert	Reverse the brightness and the colors in the image.
(7)	Profiles	Save or change the scanning setting in the dialog box of Scanner Properties.
(8)	Defaults	Reset values in this and all other Properties tabs to the original factory settings.

Paper settings

Click **Setup** , and then click the **Paper** tab to define values related to image output.

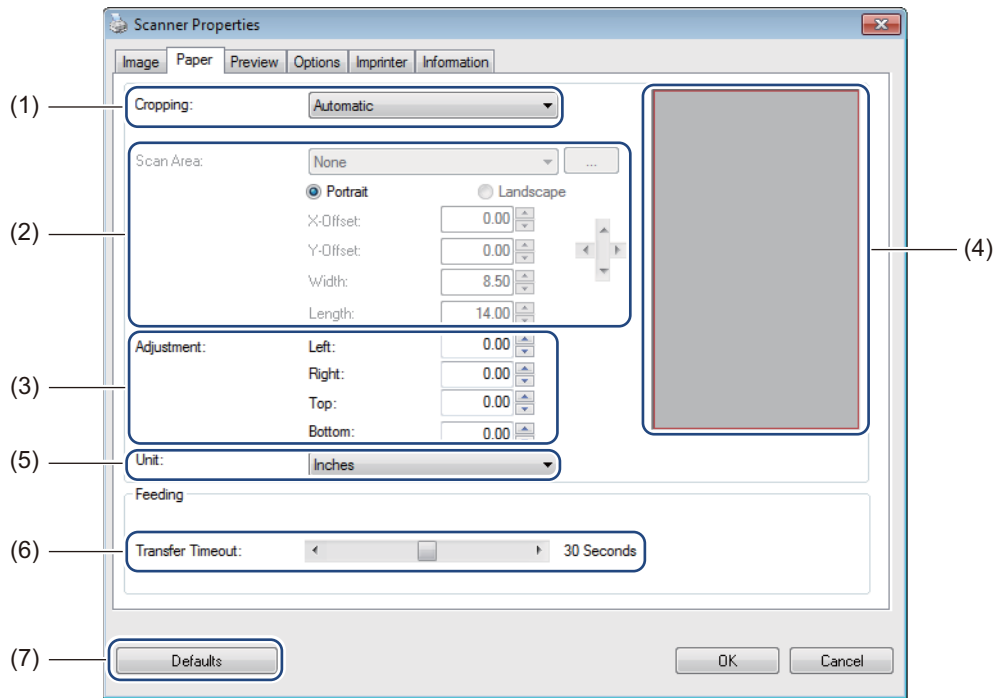

(1)	Cropping	<p>Cropping allows you to capture a portion of the scanned document.</p> <ul style="list-style-type: none"> ■ Automatic Choose Automatic to allow the software to adjust the cropping window according to the document size. Use this option for batches of mixed-sized documents. ■ Fix for Transfer Choose Fix for Transfer if you want the ability to define the area or zone to be imaged. Use for batches of same-sized documents.
-----	-----------------	--

(2)	Scan Area	<p>Choose your paper size from the drop-down list or create a custom paper size by clicking Add in the drop-down list.</p> <p>If you selected Fix for Transfer in Cropping (1), define the X-Offset and Y-Offset or specify Width and Length to redefine the scan area. The Display Area (4) in this screen displays image placement as you change the values.</p> <ul style="list-style-type: none"> • X-Offset - the distance from the left edge of the document to the left edge of the scanned area. • Y-Offset - the distance from the top edge of the document to the top edge of the scanned area. • Width - the width of the scanned area. • Length - the length of the scanned area. <ul style="list-style-type: none"> •  Use these arrows (or your mouse) to move the scan area; you can view the results in the Display Area of this screen.
(3)	Adjustment	<p>Adjustment allows you to add a specific margin at left, right, top and bottom of your image. This may help to reduce possible corner clipping on any skewed images. Select a value from 0 to +5 mm. The Adjustment result will not appear in the Display Area.</p>
(4)	Display Area	Displays image placement as you change the values in Scan Area (2).
(5)	Unit	Unit allows you to define your preferred measurement system. Select Inches , Millimeters , or Pixels from the drop-down list.
(6)	Transfer Timeout	<p>Transfer Timeout allows you to set the amount of time (in seconds) the scanner will wait before starting automatic scan after the first scan job is completed. When you have many separate documents that need to be scanned with the same scan settings, this feature is especially useful. The default time is 30 seconds.</p> <p>The value ranges from 0 to 60 seconds.</p>
(7)	Defaults	Reset values in this and all other Properties tabs to the original factory settings.

Preview settings

Click **Setup** , and then click the **Preview** tab to preview your image before the final scan so that you can set your scan area correctly.

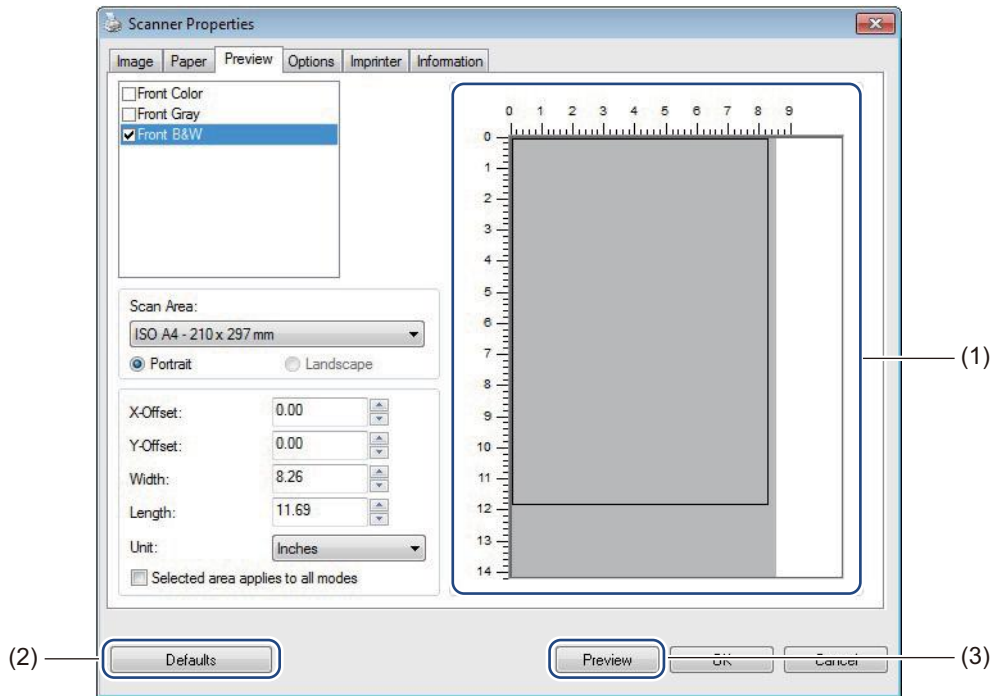

(1)	Preview Window	When you click Preview (3), the scanned image will appear in this area. This preview image lets you define your scan area.
(2)	Defaults	Reset values in this and all other Properties tabs to the original factory settings.
(3)	Preview	Click to start the preview scan. The scanned image will appear in the Preview Window (1). Note that the scanned image is only for the preview and will not be saved.

NOTE

If you chose **Automatic** cropping, in the **Paper** tab screen, you cannot preview your scan on this screen.

Options settings

Click **Setup** , and then click the **Options** tab to set additional image processing settings or calibrate your scanner.

NOTE

This image is from the DS-920DW.

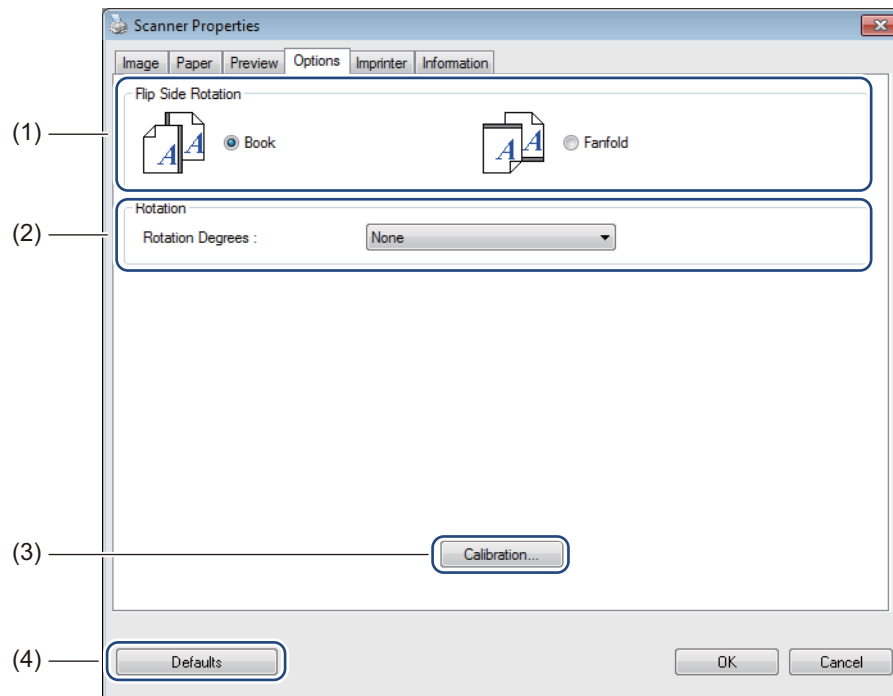

(1)	Flip Side Rotation (DS-920DW only)	<ul style="list-style-type: none"> ■ Book Select Book to maintain the same image orientation on the reverse side of the output page. ■ Fanfold Select Fanfold to rotate the image orientation 180 degrees on the reverse side of the output page.
(2)	Rotation	Choose the rotation angle from the drop-down list if you want to rotate your scanned image.
(3)	Calibration	<p>Calibrate the scanner.</p> <p>For more information, see <i>Calibration using software (for Windows®)</i> on page 59.</p>
(4)	Defaults	Reset values in this and all other Properties tabs to the original factory settings.

Imprinter settings

Click **Setup** , and then click the **Imprinter** tab to print alphanumeric characters, date, time, document count and custom text on your scanned images.

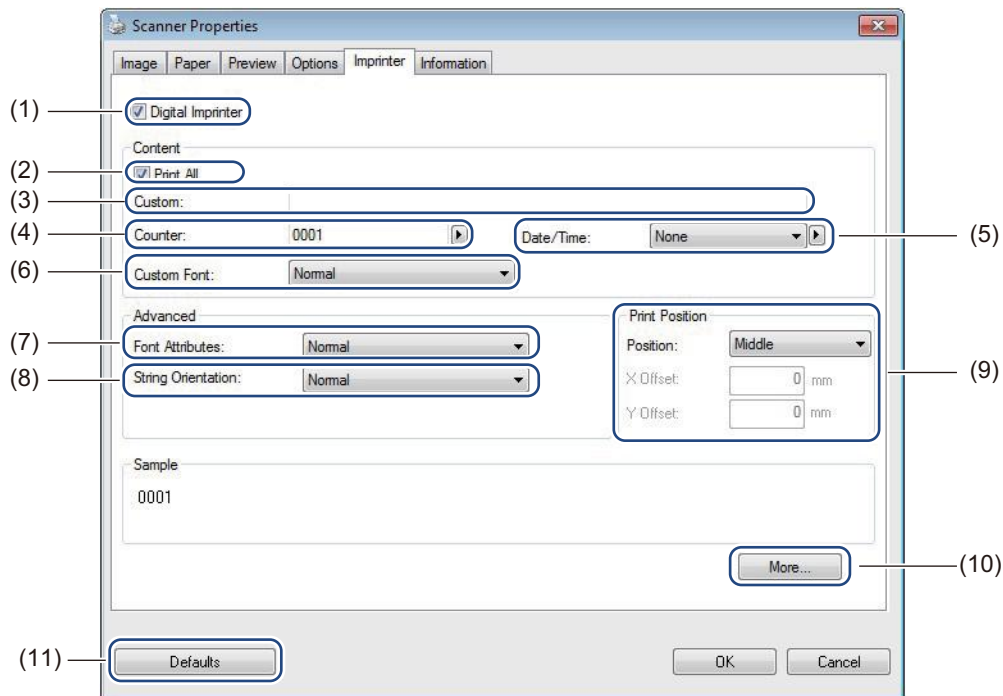

(1)	Digital Imprinter	Select Digital Imprinter to print the message on the front of your scanned image.
(2)	Print All	Select the Print All check box to print your print string (message) on all pages of your document. Clear the Print All check box to print the print string on the first page only.
(3)	Custom	Type the text you want to print.
(4)	Counter	Displays the page count for the scan session.
(5)	Date / Time	Select a format from the drop-down list if you want to include the date and time in your print string.
(6)	Custom Font	Click the drop-down list to select a font for your print string.
(7)	Font Attributes	Select a font attribute from the drop-down list. Options include Normal , Underline , Double , or Bold .
(8)	String Orientation	Select a print string orientation from the drop-down list. Options include Normal , Rotated , Vertical , Vertical Inversion , 90 Degrees CW or 90 Degrees CCW .
(9)	Print Position	Select the position of your print string from the drop-down list. Options include Top , Middle , Bottom , or Custom . If you choose Custom , enter the X Offset and Y Offset values to specify the position.
(10)	More	Click More... to set Size , Density and Transparency for your print string.
(11)	Defaults	Reset values in this and all other Properties tabs to the original factory settings.

Information

Click **Setup** , and then click the **Information** tab to view system and scanner information.

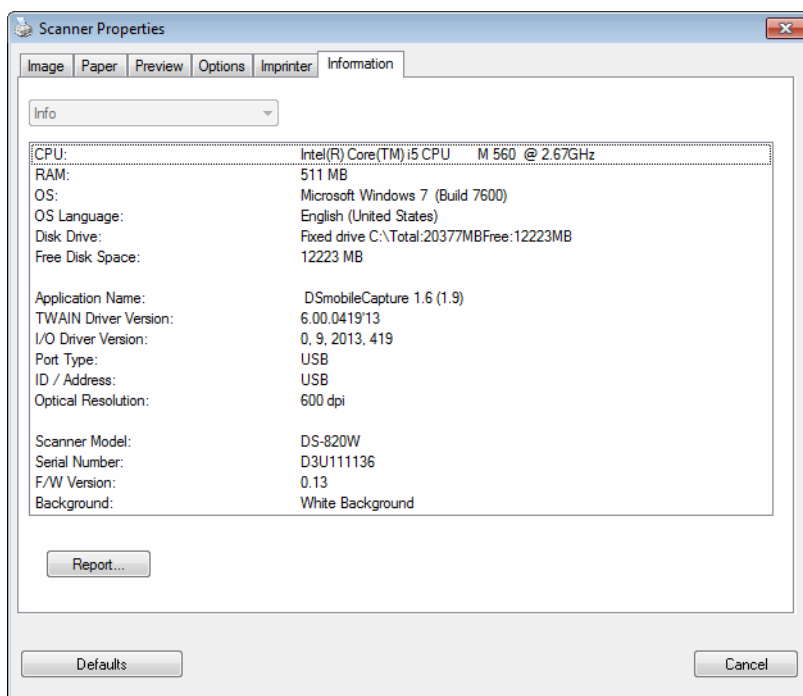

Using DSmobileCapture (for Macintosh)

- 1 Connect the supplied Micro USB Cable to the Micro USB port on your scanner. Connect the cable to your computer.
- 2 Double-click the **DSmobileCapture** shortcut  on your desktop.
- 3 **DSmobileCapture** launches.

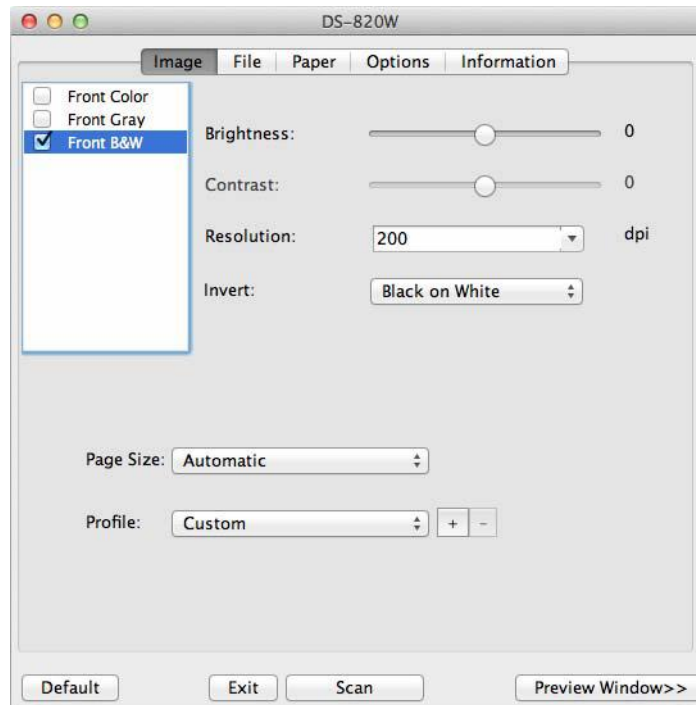

- 4 Change the scanning settings, if needed.
For more information on changing settings, see *Changing DSmobileCapture scan settings (for Macintosh)* on page 36.
- 5 Insert a document into your scanner.
- 6 Click **Scan** in the DSmobileCapture screen or press the scanner's **Start / OK** button.
Your scanner starts scanning. The scanned image will be saved in the directory you specified in step 4. Check the scan result just in case.

Changing DSmobileCapture scan settings (for Macintosh)

Image settings

Click the **Image** tab to choose image type and to set several basic scan settings.

NOTE

This image is from the DS-920DW.

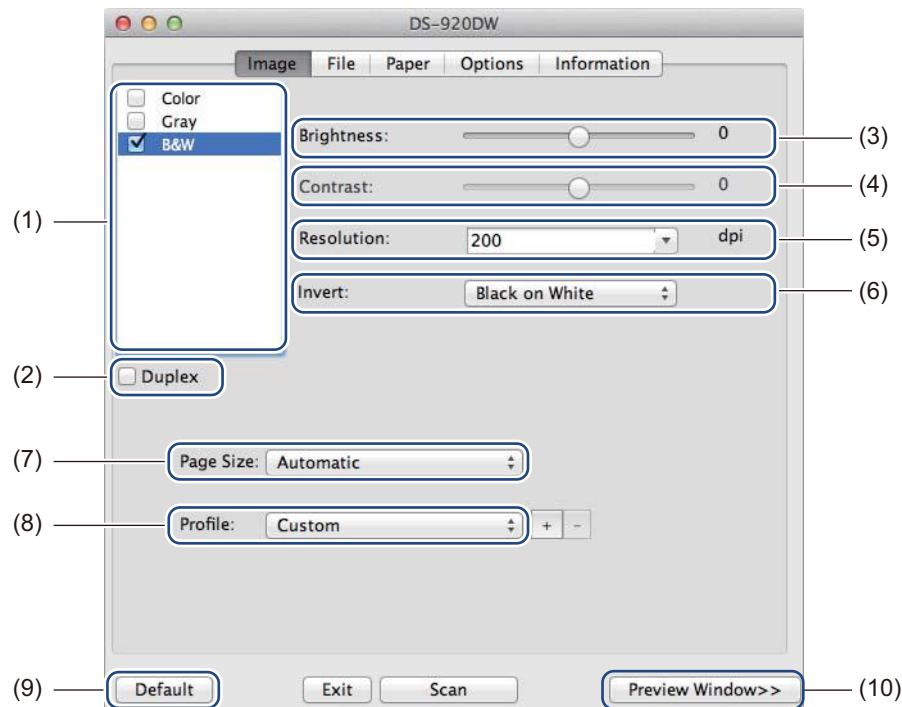

(1)	Image Selection Box	Choose the type of document you want to scan.
(2)	Duplex	(DS-920DW only) Select the Duplex check box to perform Duplex (2 side) scanning.
(3)	Brightness	Adjusts the lightness or darkness of an image. The range is from -100 to +100 . The factory default is 0 .
(4)	Contrast	Adjusts the range between the darkest and the lightest shades in the image. The range is from -100 to +100 . The factory default is 0 .
(5)	Resolution	Determine the quality of the scanned image. The factory default is 200 dpi .
(6)	Invert	Reverse the brightness and the colors in the image.
(7)	Page Size	Page Size allows you to capture a portion of the scanned document. Choose your paper size from the Page Size pop-up list.
(8)	Profiles	Save or change the scanning setting in the dialog box of Scanner Properties.
(9)	Default	Reset values in this and all other Properties tabs to the original factory settings.

(10)	Preview Window	Click to preview your image before final scan. This preview image lets you define your scan area. When you click Preview , scanning for the preview starts and the scanned image will appear in the Preview Window . Note that the scanned image is only for the preview and will not be saved.
------	-----------------------	--

File settings

Click the **File** tab to configure the settings related to the file name and the directory where you want to save the scanned image.

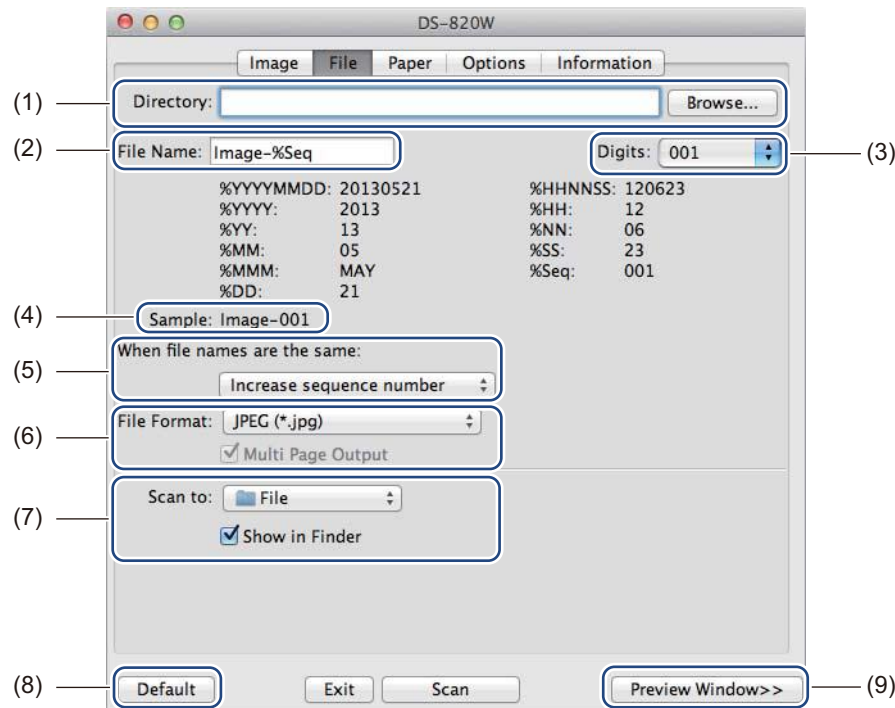

(1)	Directory	Specify the directory where you want to save scanned images.
(2)	File Name	Set the rule for the file name of the scanned image.
(3)	Digits	Determine the starting number of the sequence number that is included in the file name.
(4)	Sample	Preview the file name that you set.
(5)	When file names are the same	Change the file name if the same name already exists in the directory you chose in Directory .
(6)	File Format	Choose the file format for the scanned image. When you choose TIFF or PDF , the Multi Page Output option is available. You can continue to scan the next document after the first scan job is completed.
(7)	Scan to	Choose the destination to send the scanned image.
(8)	Default	Reset values in this and all other Properties tabs to the original factory settings.
(9)	Preview Window	Click to preview your image before final scan. This preview image lets you define your scan area. When you click Preview , scanning for the preview starts and the scanned image will appear in the Preview Window . Note that the scanned image is only for the preview and will not be saved.

Paper settings

Click the **Paper** tab to define values related to image output.

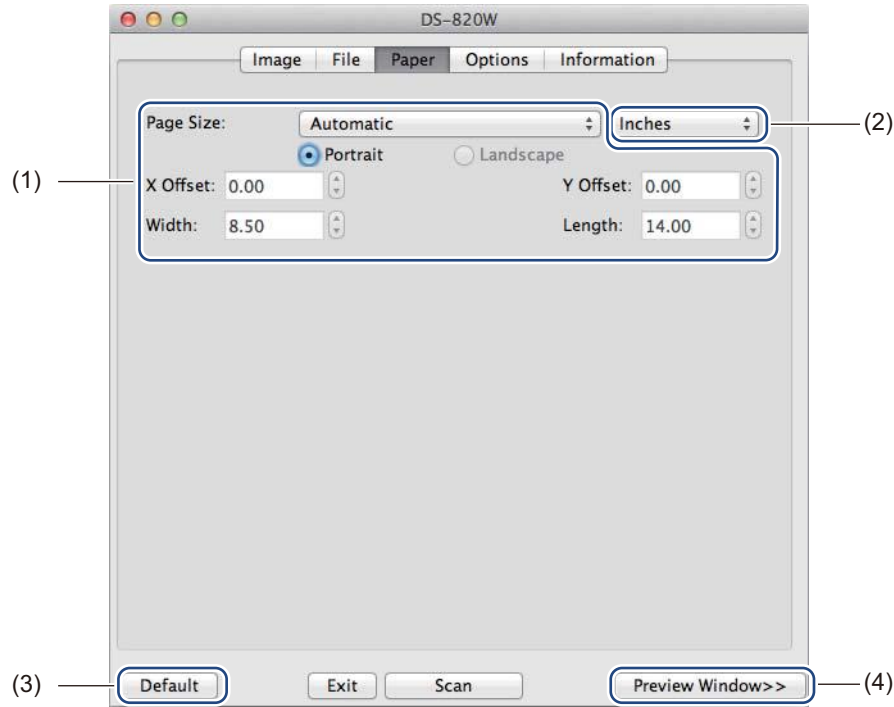

(1)	Page Size	<p>Page Size allows you to capture a portion of the scanned document. Choose your paper size from the Page Size pop-up list, define the X Offset and Y Offset values or specify Width and Length to define your scanned area. Click Preview Window (4) to preview image placement as you change the values.</p> <ul style="list-style-type: none"> • X Offset - the distance from the left edge of the document to the left edge of the scanned area. • Y Offset - the distance from the top edge of the document to the top edge of the scanned area. • Width - the width of the scanned area. • Length - the length of the scanned area.
(2)	Unit	<p>Unit allows you to define your preferred measurement system. Select Inches, Millimeters, or Pixels from the pop-up list.</p>
(3)	Default	<p>Reset values in this and all other Properties tabs to the original factory settings.</p>
(4)	Preview Window	<p>Click to preview your image before final scan. This preview image lets you define your scan area.</p> <p>When you click Preview, scanning for the preview starts and the scanned image will appear in the Preview Window. Note that the scanned image is only for the preview and will not be saved.</p>

Options settings

Click the **Options** tab to set some additional image processing settings or calibrate your scanner.

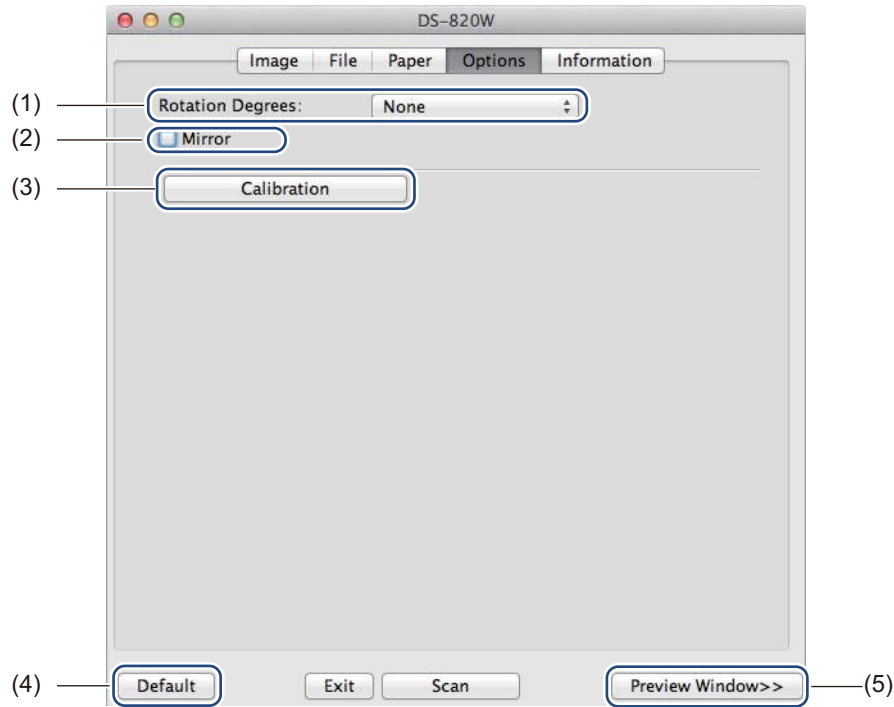

(1)	Rotation Degrees	Choose the rotation angle from the pop-up list if you want to rotate your scanned image.
(2)	Mirror	Select the Mirror check box to reverse your image.
(3)	Calibration	Calibrate the scanner. For more information, see <i>Calibration using software (for Macintosh)</i> on page 62.
(4)	Default	Reset values in this and all other Properties tabs to the original factory settings.
(5)	Preview Window	Click to preview your image before final scan. This preview image lets you define your scan area. When you click Preview , scanning for the preview starts and the scanned image will appear in the Preview Window . Note that the scanned image is only for the preview and will not be saved.

Information

Click the **Information** tab to view system and scanner information.

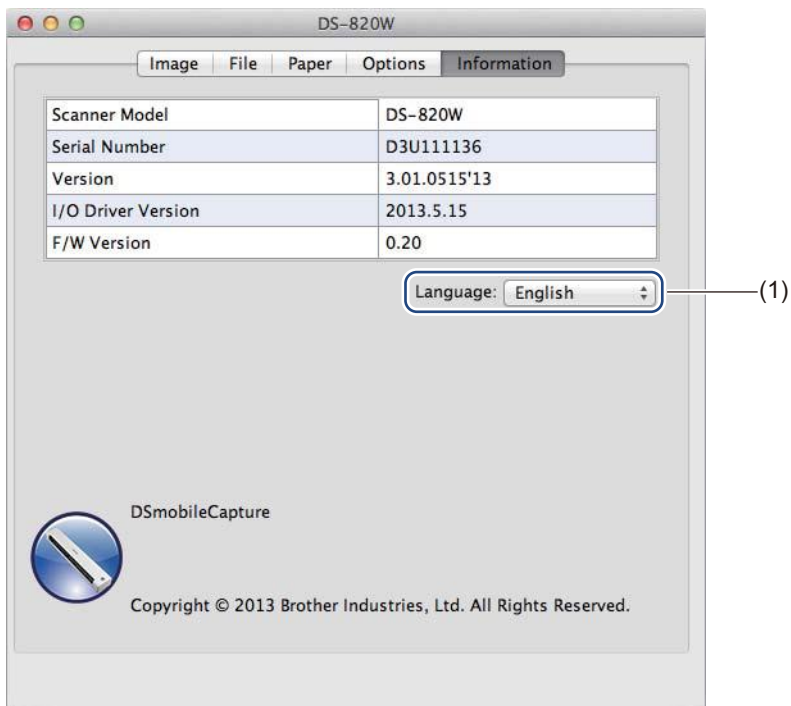

(1)	Language	Choose the language you want to display from the pop-up list.
-----	-----------------	---

Using Button Manager V2 (for Windows®)

NOTE

- For more detailed instructions, see the *Button Manager V2 User's Guide* from the application's help menu.
- To see the help menu, right-click the **Button Manager V2** icon  on the system tray, and then click **Help**.

Use either one of these two methods to launch **Button Manager V2** Button Panel.

To display the shortcut icon and launch Button Manager V2 Button Panel from your system tray

5

- 1 Connect the Micro USB Cable to the Micro USB port on your scanner. Connect the Micro USB Cable to a USB port on your computer.
- 2 Click the **Button Manager V2** icon  on the system tray at the bottom right corner of your computer screen.
- 3 **Button Manager V2** Button Panel launches.

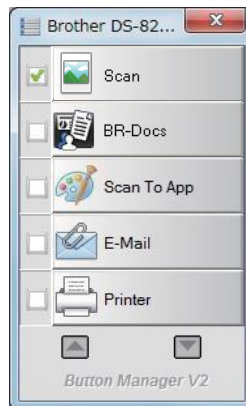

To launch **Button Manager V2** Button Panel from the **Windows®** Start button

- 1 Click **Start**  > **All Programs** > **Brother DS-820W (DS-920DW) Scanner** > **Button Manager** > **Button Manager V2**.
- 2 When the **Select Scanner Model** dialog box appears, select your scanner model from the list, and then click **OK**.
- 3 **Button Manager V2** Button Panel launches.

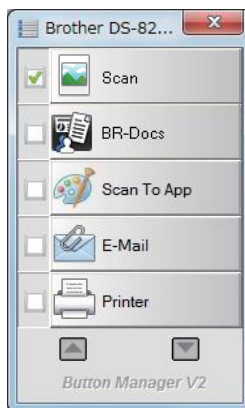

Scanning method

To scan using the scan button on **Button Manager V2** Button Panel

- 1 Insert a document into your scanner.
- 2 Launch **Button Manager V2** Button Panel.
- 3 If necessary, right-click the desired scan button in the **Button Manager V2** Button Panel to change scan settings.
For more information, see the *Button Manager V2 User's Guide*.
- 4 Click the scan button you want to use in the **Button Manager V2** Button Panel to start scanning.

Scan buttons in the Button Manager V2 Button Panel (for Windows®)

Scan to an image

Use this option to open the scanned image in a specific application. Note that the application must already be open and running on your computer.

To change scan settings, right-click the **Scan**



button (see the *Button Manager V2 User's Guide*).

- 1 Insert a document into your scanner.
- 2 Launch **Button Manager V2** Button Panel.

- 3 Click **Scan**

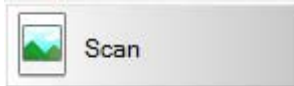

When scanning is complete, the scanned image will be inserted to your open and running application. Check the scan result just in case.

NOTE

- If no application launches or the application is minimized, the scanned image will be saved in a predefined folder (for more information about changing the folder path, see the *Button Manager V2 User's Guide*).
 - If two or more applications are open, the scanned image will appear in the active application.
-

Scan to BR-Docs

Use this option to save scanned image in BR-Docs.

To change scan settings, right-click the **BR-Docs**

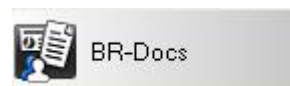

button.

- 1 Insert a document into your scanner.
- 2 Launch **Button Manager V2** Button Panel.
- 3 Click **BR-Docs**

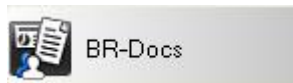

to start scanning.

When scanning is complete, the scanned image will be sent directly to BR-Docs. Check the scan result just in case.

NOTE

For more information about **BR-Docs**, see the *Button Manager V2 User's Guide*.

Scan to an application

Use this option to open the scanned image with a application that you choose from a list.

To change scan settings, right-click the **Scan to App**  button.

- 1 Insert a document into your scanner.
- 2 Launch **Button Manager V2** Button Panel.
- 3 Click **Scan to App**  to start scanning.

When scanning is complete, the scanned image will be opened with the application you chose from the displayed list.

Check the scan result just in case.

Scan to an email

Use this option to attach the scanned image to an email.

To change scan settings or email software, right-click the **E-mail**  button.

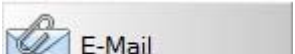
- 1 Insert a document into your scanner.
- 2 Launch **Button Manager V2** Button Panel.
- 3 Click **E-mail**  to start scanning.

When scanning is complete, your email software launches and the scanned image will be attached to a blank email.

Check the scan result just in case.

Scan to a printer

Use this option to print the scanned image from your default printer.

To change scan settings or destination printer, right-click the **Printer**  button.

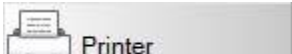
- 1 Insert a document into your scanner.
- 2 Launch **Button Manager V2** Button Panel.
- 3 Click **Printer**  to start scanning.

When scanning is complete, the scanned image will be printed from your default printer. Check the scan result just in case.

Scan to shared folder

Use this option to save the scanned image in a shared folder on your network.

To change scan settings, right-click the **Shared Folder**  button.

- 1 Insert a document into your scanner.
- 2 Launch **Button Manager V2** Button Panel.
- 3 Click **Shared Folder**  to start scanning.

When scanning is complete, the scanned image will be sent directly to the shared folder. Check the scan result just in case.

Scan to a FTP server

Use this option to save the scanned image in a folder on your FTP server.

To change scan settings, right-click the **FTP**  button.

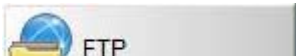
- 1 Insert a document into your scanner.
- 2 Launch **Button Manager V2** Button Panel.
- 3 Click **FTP**  to start scanning.

When scanning is complete, the scanned image will be sent directly to the folder on your FTP server. Check the scan result just in case.

6

Wi-Fi® Connection

Connecting in access point (AP) mode

You can connect your wireless device (computer, smartphone, tablet, etc.) to your scanner. Your scanner itself can be the access point without going through any access point, and your wireless device can access the scanned images stored on the SD card directly.

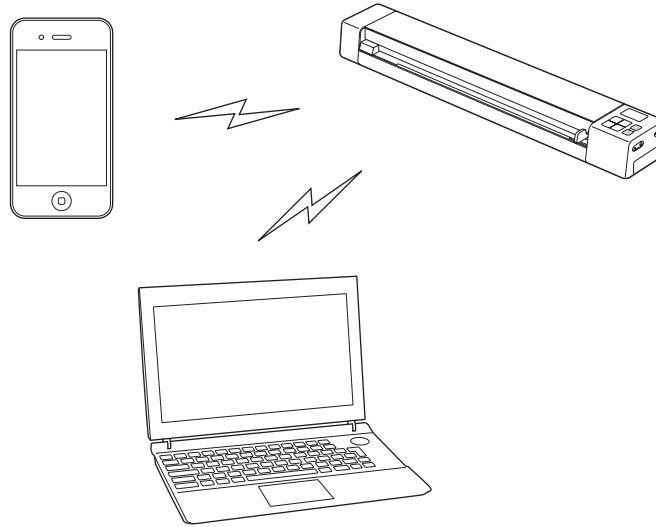

NOTE

- If you have not set a Wi-Fi® network password, be sure to set up a network password in your web browser first. For more information, see *Setting a Wi-Fi® network password* on page 51.
- Without a Wi-Fi® network password, data on your SD card can be viewed and stolen by a third party.
- If you forget your password, press the scanner's **RESET** button to reset the password. For more information, see *Reset network settings* on page 57.
- Up to three wireless devices can connect to your scanner at a time.

- 1 Slide the Wi-Fi® switch to **ON**.

Wait for about 40 seconds until the Wi-Fi® indicator turns from red to blue.

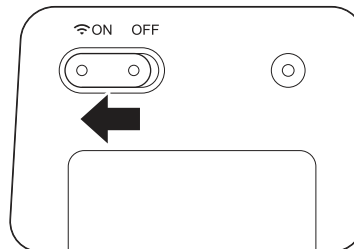

- 2 Activate the Wi-Fi® function of your wireless device (computer, smartphone, tablet, etc.) to select the scanner.
For more information, see the instructions provided with your wireless device.

- 3 Select the scanner's SSID, **Brother DS-820W-xxxx (Brother DS-920DW-xxxx)** (where xxxx is your model name).

7

Scan to the Cloud Server Using a Wireless Access Point (BOL Mode)

You can store scanned images with **Brother Online** storage services (BOL) in **BR-Docs**. Configure access using your scanner's control panel.

NOTE

- To use this function, you must first configure your **BOL (Brother Online) Account** in a web browser. (See *Configure network settings* on page 56.) Configure Wi-Fi® Settings for Internet access in your web browser, and then connect your scanner to the Internet via an access point (see *Configure network settings* on page 56).
- When you use this function, a file that is 50 MB or more cannot be scanned.

- 1 Slide the Wi-Fi® switch to **ON**.

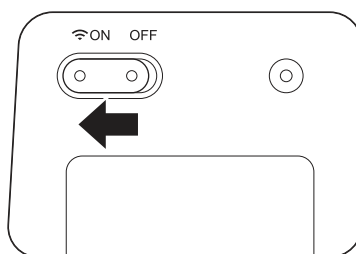

Wait about 40 seconds until the Wi-Fi® indicator turns from red to blue.

When your scanner makes a connection to your access point the Wi-Fi® indicator starts blinking blue.

- 2 Insert the SD card into your scanner.
- 3 Make sure that **SD** appears on the LCD
- 4 On the scanner's control panel, press **Menu**.
- 5 Press ◀ or ▶ until **BRD** is displayed on the LCD.
- 6 Insert your document.
- 7 Your scanner starts scanning automatically.
The **Power** LED blinks green and the SD card indicator blinks on the LCD.
- 8 When scanning is completed, your scanner starts transferring the scanned image to **BR-Docs**.
The Wi-Fi® indicator blinks orange while transferring.
- 9 When transferring is completed, the Wi-Fi® indicator turns blue.
Check the scan result just in case.

Using your web browser

You can use your wireless device's (computer, smartphone, tablet, etc.) web browser to view the scanned images stored on the scanner's SD card and download the scanned images to your wireless device.

- 1 Connect your wireless device to your scanner in AP mode.
For more information, see *Connecting in access point (AP) mode* on page 48.
- 2 Launch your wireless device's web browser.
- 3 Type **http://10.10.100.1** in the address bar.
- 4 When you view the scanned image in the browser for the first time, the **Password Setup** screen appears. Set your password, and then click **Apply**.
If you have already set the password, type the password to log in.
- 5 The home screen appears in the browser.

NOTE

Images will not appear when there is no data on the SD card.

Setting a Wi-Fi[®] network password



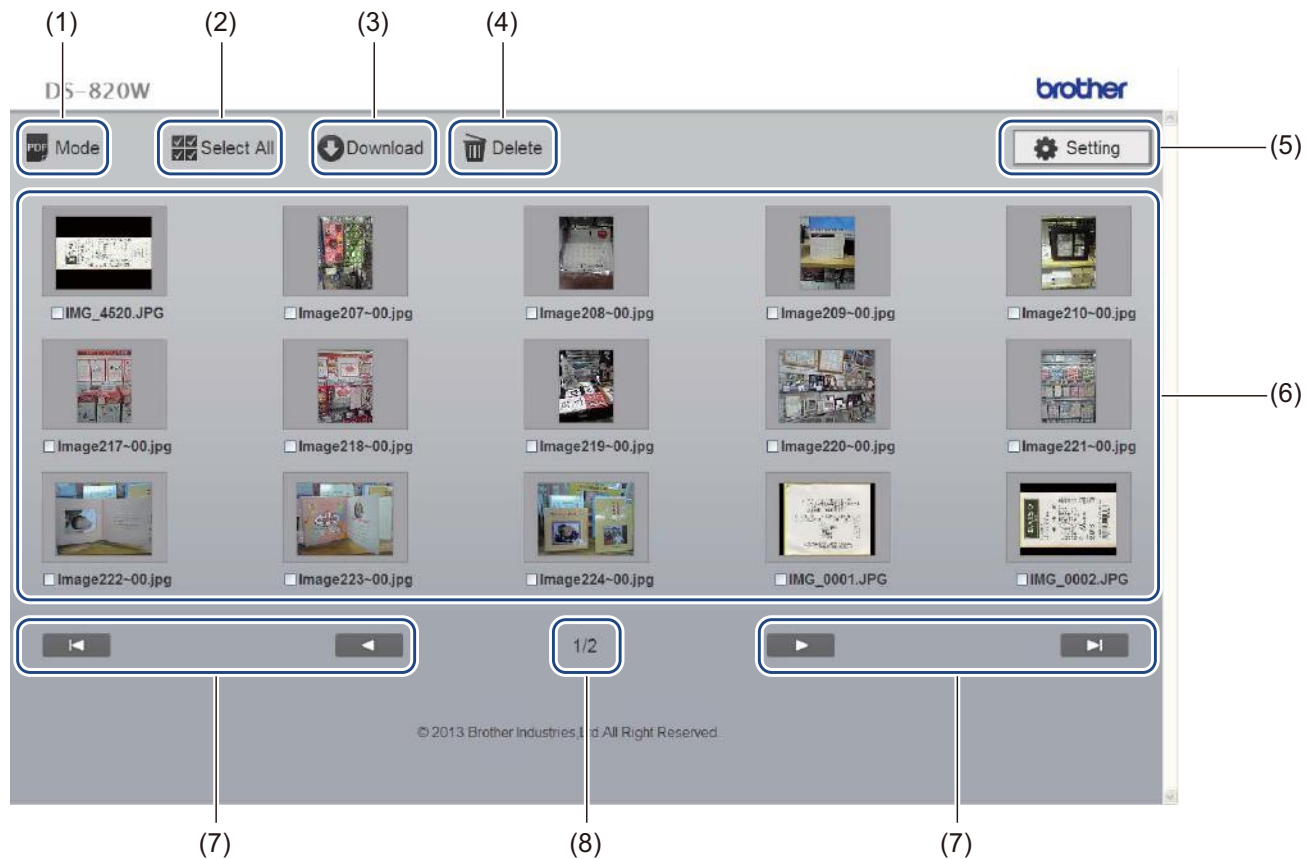

If you have not set a Wi-Fi[®] network password, be sure to set up a network password in your web browser first. Without a Wi-Fi[®] network password, data on your SD card can be viewed and stolen by a third party.

- 1 Connect your wireless device to your scanner in AP mode.
For more information, see *Connecting in access point (AP) mode* on page 48.
- 2 Launch your wireless device's web browser.
- 3 Type **http://10.10.100.1** in the address bar.
- 4 When you view the scanned image in the browser for the first time, the **Password Setup** screen appears. Set your password, and then click **Apply**.
If you have already set the password, type the password to log in.
- 5 The home screen appears in the browser.
- 6 Click **Setting** > **Wi-Fi Setting**. Then, **Wi-Fi Setting** screen appears.
- 7 Select **WPA2(AES)** from **Encryption** drop-down list.
- 8 Type **Pre-shared Key**, and click **Apply**.
- 9 **Rebooting...** screen appears, and the setting is completed.

Access Scanned Images on the SD Card



(1)	Mode	Click to switch the scanned image according to the file format (PDF or JPEG).
(2)	Select All	Click to select all check boxes.
(3)	Download	Click to download the file that is checked in the box.
(4)	Delete	Click to delete the file that is checked in the box.
(5)	Setting	Click to go to the settings pages. For more information, see <i>Changing Settings Using Your Browser</i> on page 56.
(6)	Thumbnail view	Displays the scanned images (up to 15 images per screen). When you double-click the scanned image in the thumbnail view, the preview screen will appear. The scanned images do not appear when there is no data on the SD card.

(7)	On-screen cursors	 <p>Click to go to the first page.</p>  <p>Click to go to the previous page.</p>  <p>Click to go to the next page.</p>  <p>Click to go to the last page.</p>
(8)	Page	Displays the number of the current page and the total number of pages.

Using the USB connection between your scanner and computer

NOTE

You cannot view the contents of the SD card when the Wi-Fi® switch is **ON** or your computer is in TWAIN mode.

(For Windows®)

- 1 Connect the Micro USB Cable to the Micro USB port on your scanner. Connect the cable to your computer.
- 2 Click **Start**  > **Computer**, and then double-click **Removable Disk**.
- 3 Double-click **DCIM**.
The folders on the SD card appear.
 - **100PHOTO** folder
Stores the scanned images in JPEG format.
 - **200DOC** folder
Stores the scanned images in PDF format.

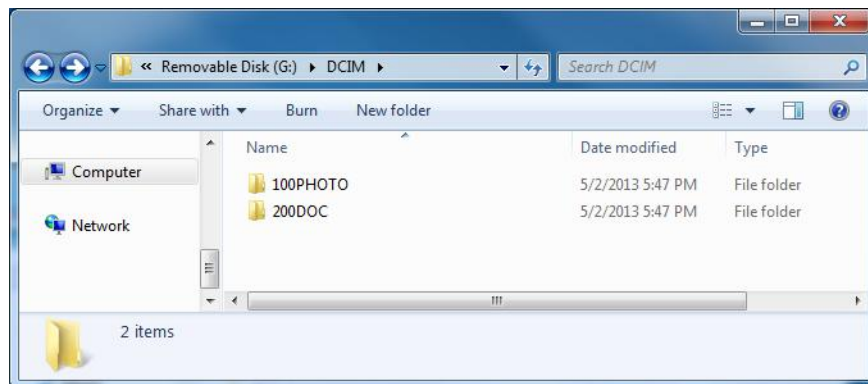

(For Macintosh)

- 1 Connect the Micro USB Cable to the Micro USB port on your scanner. Connect the cable to your computer.
- 2 iPhoto launches automatically, and the scanned images on the SD card will appear.

Using ScanHub™ (Android™)

You can use your Android™ device's application to view the scanned images stored on the scanner's SD card and download scanned images to the Android™ device.

Install the application from Google Play to your Android™ device. To download, install, or uninstall the Android™ application, see the instructions provided with your device.

NOTE

- If you have not set a Wi-Fi® network password, be sure to set up a network password in your web browser first. For more information, see *Setting a Wi-Fi® network password* on page 51.
 - Without a Wi-Fi® network password, data on your SD card can be viewed and stolen by a third party.
-

Using ScanHub™ (iOS)

You can use your iOS device's application to view the scanned images stored on the scanner's SD card and download scanned images to the iOS device.

Install the application from the App Store to your iOS device. To download, install, or uninstall the iOS application, see the instructions provided with your device.

NOTE

- If you have not set a Wi-Fi® network password, be sure to set up a network password in your web browser first. For more information, see *Setting a Wi-Fi® network password* on page 51.
 - Without a Wi-Fi® network password, data on your SD card can be viewed and stolen by a third party.
-

Configuring Wi-Fi[®] settings in access point (AP) mode

Configure network settings

You can configure network settings in your browser.

- 1 Access the browser in AP mode.
For more information, see *Connecting in access point (AP) mode* on page 48.
- 2 Click **Settings**.

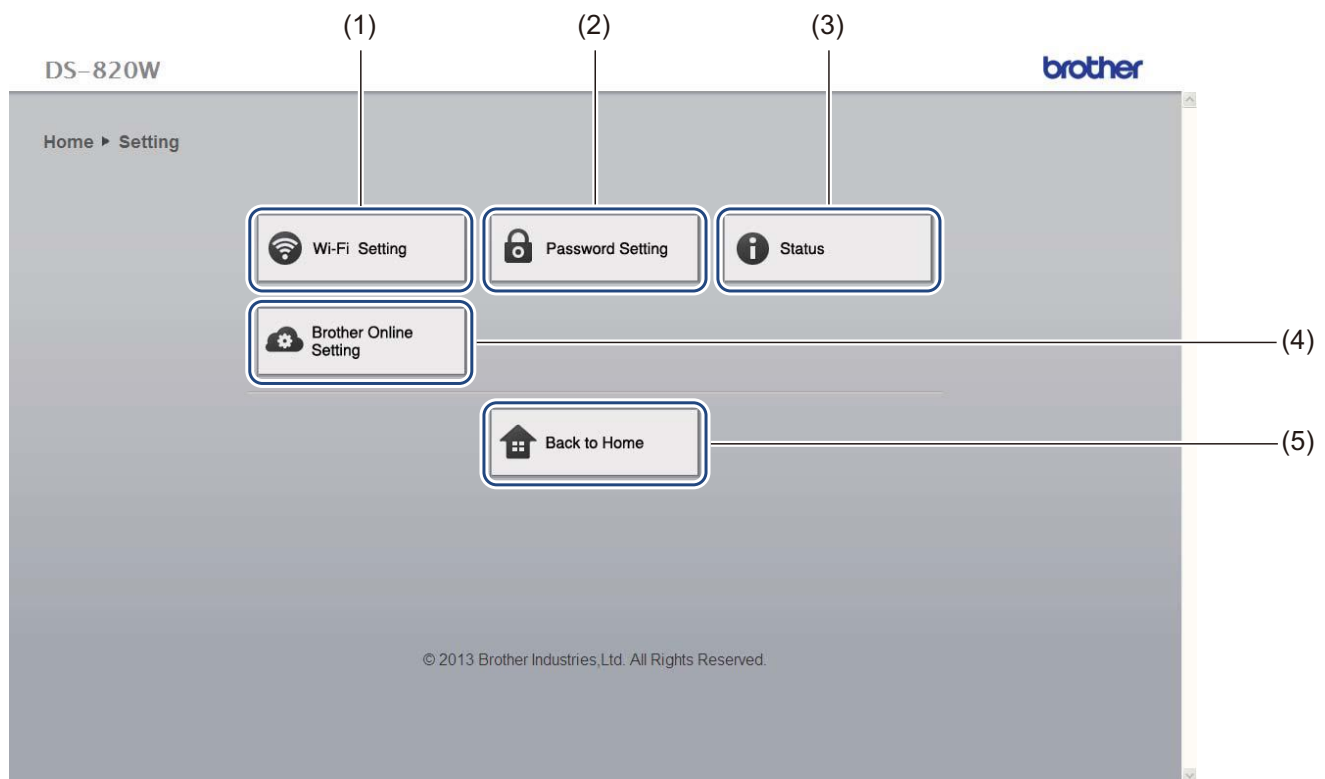

(1)	Wi-Fi Setting	Set the SSID (network name) and Pre-Shared Key.
(2)	Password Setting	Set the password to log in.
(3)	Status	Check the status of the current access point. Check the firmware version.
(4)	Brother Online Setting	Configure your BOL (Brother Online) Account . Configure Wi-Fi [®] settings for Internet access in infrastructure mode.
(5)	Back to Home	Return to the Home screen.

Reset network settings

You can restore any settings you changed via Wi-Fi® connection (**Wi-Fi® AP Setting** and **Password Setup**) to the factory settings.

- 1 Press and hold the scanner's reset button (1) using a pointed object, such as a needle or a fine-point pen for 10 seconds.

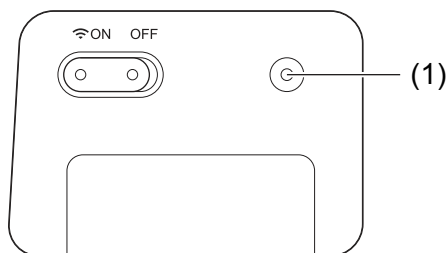

NOTE

When you press the reset button, the settings controlled by the buttons on the control panel will **not** be restored to the factory settings and the scanned images on the SD card will **not** be deleted.

10

Scanner Calibration

Calibrate your scanner only if the scanned images start to look fuzzy, the color looks abnormal (darker than normal), after 8,000 scans, or if the scanner has been stored without being used for a long time.

You will need the Calibration Sheet that came with your scanner to successfully perform calibration.

Calibration using the control panel

- 1 Turn on your scanner.
- 2 Press the **Menu** button.
- 3 Press the ◀ or ▶ button repeatedly to select **CAL** on the LCD.
- 4 Hold the edges of the Calibration Sheet and insert it into the feeder slot as shown below.

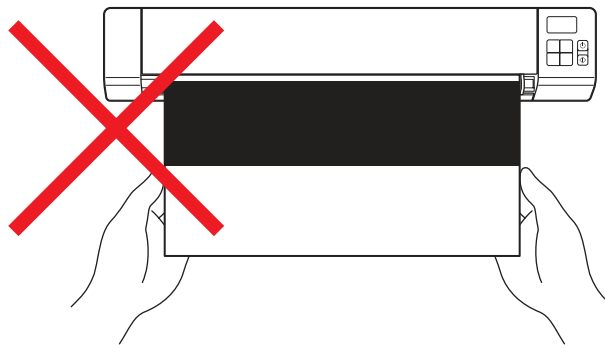
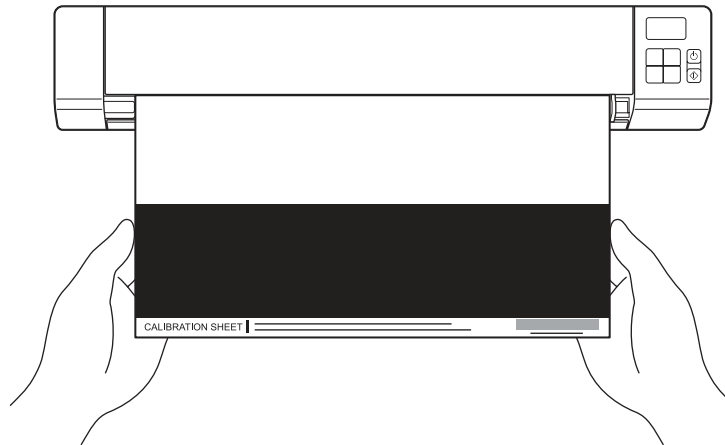



NOTE

Hold only the edges of the calibration sheet and be careful not to touch the white or black area. Leaving marks or fingerprints on this sheet can cause errors in calibration.

- 5 Press the **Start / OK** button.
- 6 The scanner starts feeding the calibration sheet. The **Power** button LED blinks green.
- 7 After the calibration sheet is ejected, **OK** appears on the LCD and calibration is finished.

Calibration using software (for Windows®)

- 1 Double-click the **DSmobileCapture** shortcut  on your desktop.
- 2 The **Select Scanner Model** dialog box appears. Select **TWAIN** under **Driver Type**, select **Brother DS-820W (DS-920DW)** under **Scanner Model**, and then click **OK**.
- 3 **DSmobileCapture** launches.
- 4 Click **Setup** .

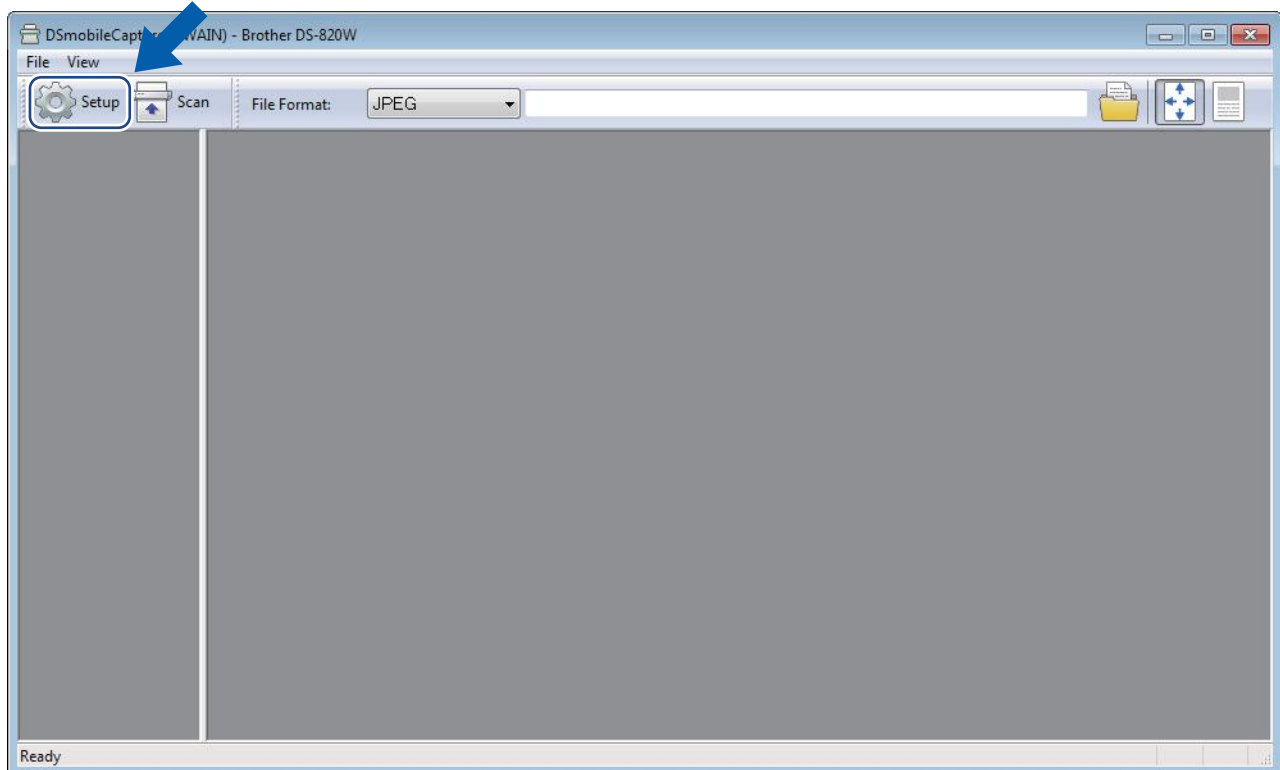

- 5 Click the **Options** tab.
- 6 Click **Calibration** to start calibrating the scanner.

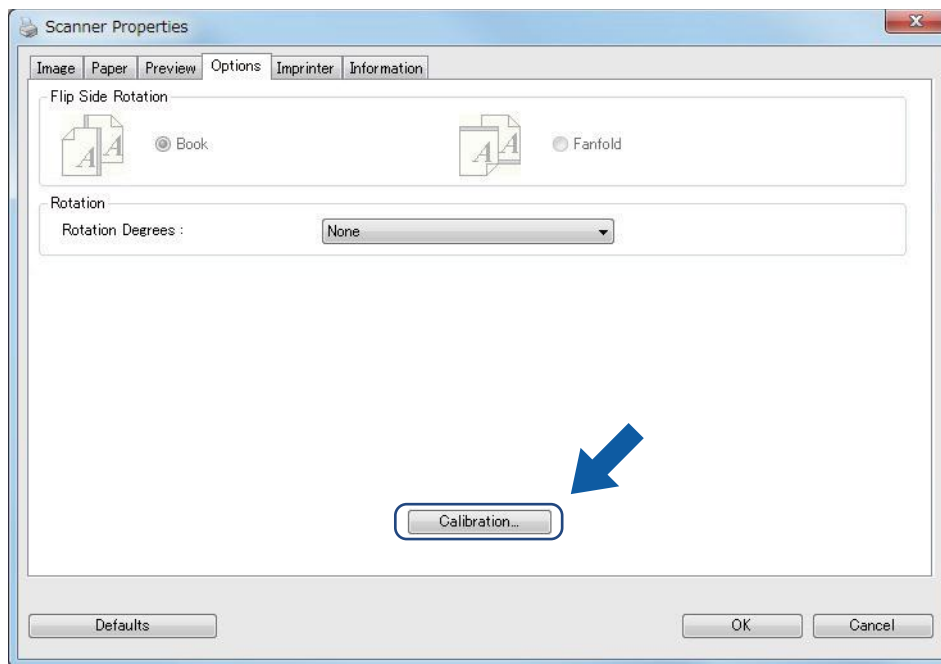

- 7 A message appears, prompting you to insert the Calibration Sheet.

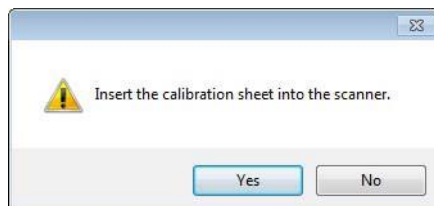

- 8 Hold the edges of the Calibration Sheet and insert it into the feeder slot as shown below. Click **Yes**.

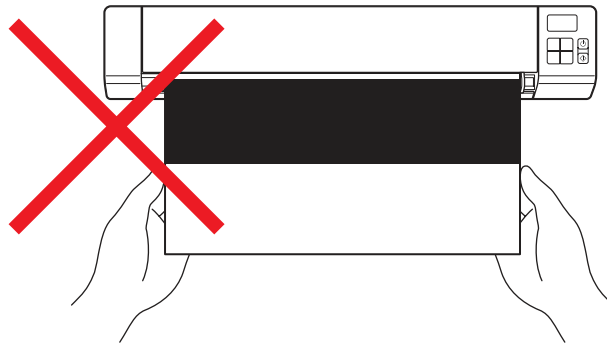
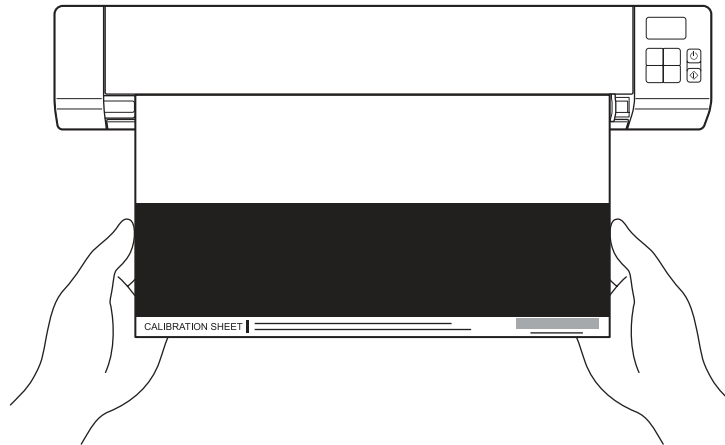

NOTE

Hold only the edges of the Calibration Sheet and be careful not to touch the white or black area. Leaving marks or fingerprints on this sheet can cause errors in calibration.

- 9 Scanning starts automatically.
- 10 After the Calibration Sheet is scanned, a **Calibration was successful** message appears on your screen, indicating that calibration is finished. Click **OK** to end calibration, and then click **OK** to close the **Options** screen.

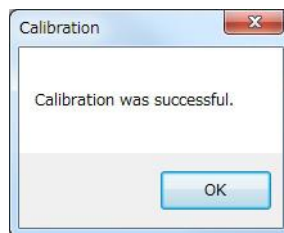

NOTE

If a **Calibration failed** message appears on your screen, remove the Micro USB Cable from your computer. Reconnect the Micro USB Cable to the computer and perform the calibration again. If calibration fails again, check the scanner's print head to ensure it is clean.

Calibration using software (for Macintosh)

- 1 Double-click the **DSmobileCapture** shortcut  on your desktop.
- 2 **DSmobileCapture** launches.
- 3 Click the **Options** tab.
- 4 Click **Calibration** to start calibrating the scanner.

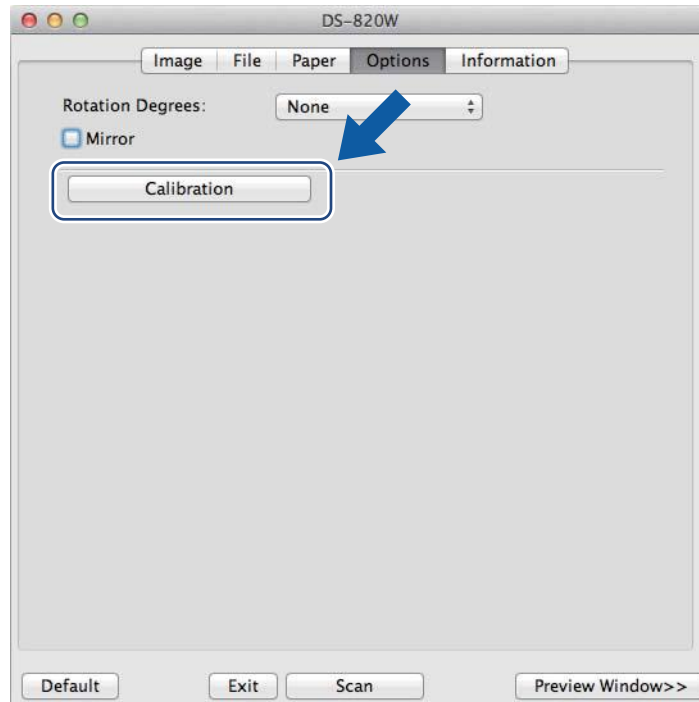

- 5 A message appears, prompting you to insert the Calibration Sheet.

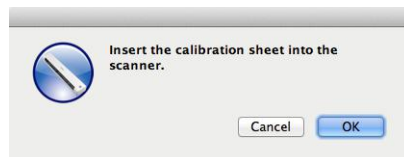

- 6 Hold the edges of the Calibration Sheet and insert it into the feeder slot as shown below. Click **OK**.

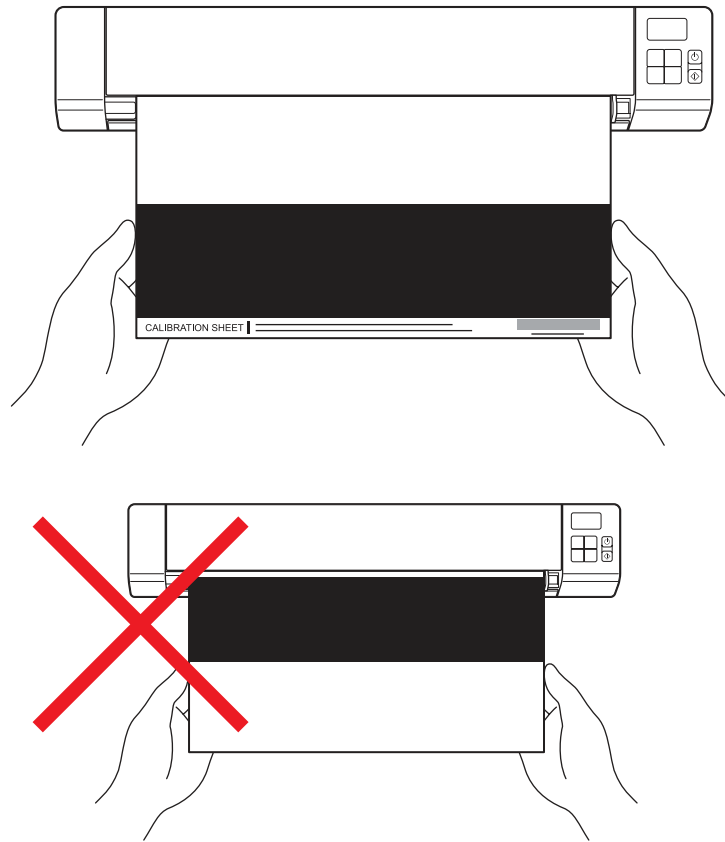

NOTE

Hold only the edges of the Calibration Sheet and be careful not to touch the white or black area. Leaving marks or fingerprints on this sheet can cause errors in calibration.

- 7 Scanning starts automatically.
- 8 After the Calibration Sheet is scanned, a **Calibration was successful** message appears on your screen, indicating that calibration finished successfully. Click **OK** to end calibration.

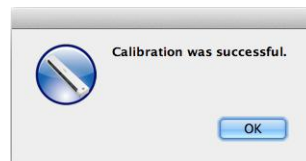

NOTE

If a **Calibration failed** message appears on your screen, remove the Micro USB Cable from your computer. Reconnect the Micro USB Cable to the computer and perform the calibration again. If calibration fails again, check the scanner's print head to ensure it is clean.

IMPORTANT

Do not use any solvents or corrosive liquid, such as alcohol, kerosene, etc., to clean any part of the scanner, or the plastic may be permanently damaged.

Cleaning the outside of your scanner

To prevent dust accumulation, we recommend cleaning the exterior of your scanner periodically.

- 1 Remove the Micro USB Cable from both your scanner and your computer.
- 2 Wipe the outside of the scanner with a dry, soft, lint-free cloth.
If necessary, wipe the exterior with a cloth lightly dampened with water or diluted detergent, and finish with a dry cloth.
- 3 Reconnect the Micro USB Cable to your scanner and your computer.

Cleaning the inside of your scanner

To maintain the scanned image quality, clean the interior of your scanner periodically. If vertical lines or stripes appear on scanned images, this indicates that it is time to clean your scanner.

- 1 Remove the Micro USB Cable from both your scanner and your computer.
- 2 Open the scanner's top cover.

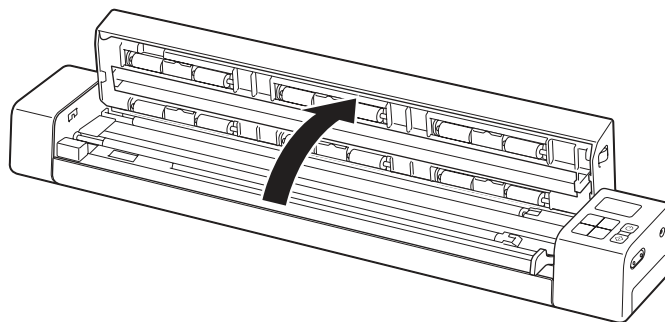

- 3 Gently wipe the glass and feed rollers with the supplied cleaning cloth.

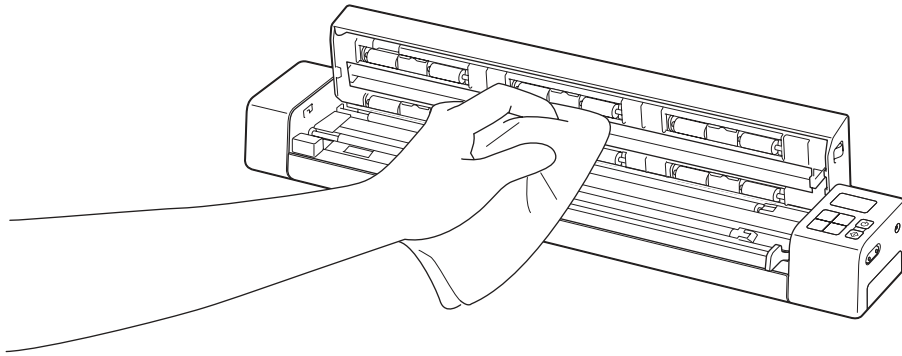

- 4 Close the top cover.
- 5 Reconnect the Micro USB Cable to your scanner and your computer.

12 Troubleshooting

IMPORTANT

For technical help, you must contact the Customer Service center in the country where you bought the scanner. For more information, see *For customer service* on page 80. Calls must be made **from within** that country.

If you think there is a problem with your scanner, check the chart below and follow the suggestions.

Most problems can be easily resolved by yourself. If you need additional help, go to the Brother Solutions Center at <http://solutions.brother.com/> for more FAQs and troubleshooting tips.

Using non-Brother supplies may affect scan quality, hardware performance and product reliability.

Error messages and Error codes

Error messages

Error message	Cause	Action
Driver busy	The scanning application in use crashed or the scanner driver is locked with administrator rights.	Press and hold the Power button to turn off the scanner, and press the Power button to turn on it. Then launch the application again.
A document is jammed. Please open the top cover and remove the jammed paper by pulling it forward, then try again.	A document is jammed.	Open the top cover and remove the document by pulling it forward, then close the top cover.
The cover of the manual document feeder is open.	Your scanner's top cover is open when scanning starts.	Close the top cover and start scanning again.
No paper in the manual document feeder	No document is set in the feeder slot.	Set your document in the feeder slot and start scanning again.
Cannot find the scanner.	Your scanner is not connected to your computer.	Confirm that the Micro USB Cable connecting the scanner to the computer is properly connected.
	Your scanner is not turned on.	Press the Power button to turn on the scanner.
Operation system return error	Your Operating System cannot recognize your scanner.	<ul style="list-style-type: none">■ Confirm that the Micro USB Cable connecting the scanner to the computer is properly connected.■ Restart the computer.

Error message	Cause	Action
Calibration failed. Please reboot the machine.	The calibration failed for some reason. For example, the Calibration Sheet is not inserted in the correct direction.	<ul style="list-style-type: none"> ■ Press and hold the Power button to turn off the scanner, and press the Power button to turn on it. Then, perform the calibration again. ■ Insert the Calibration Sheet in the correct direction. • To perform the calibration using the control panel, see <i>Calibration using the control panel</i> on page 58. • For Windows®: to perform the calibration using software, see <i>Calibration using software (for Windows®)</i> on page 59. • For Macintosh: to perform the calibration using software, see <i>Calibration using software (for Macintosh)</i> on page 62.

Error Codes

Error Code	Items Description	Root cause / Code Purpose	How to restore
E03	Card full or Card Read / Write error	The SD card is full, protected, or corrupt; scanned images cannot be saved to the SD card.	Check the SD card's protective switch, reinsert the SD card, or insert a new SD card.
E04	Paper Jam	Scan exceeds the maximum length, and cannot successfully eject the scanned document.	Open the top cover and remove the document, then close the cover and try to scan again.
E05	Missing Scan Data	Scanner does not detect a document in the document feeder slot.	Make sure the document is properly inserted.
E06	Cover Open	The scanner's top cover is open, or the top cover sensor has failed.	Close the scanner's top cover.
E19	Calibration Fail	The scanner's internal check failed because of a calibration data error.	<p>Recalibrate the scanner.</p> <ul style="list-style-type: none"> • To perform the calibration using the control panel, see <i>Calibration using the control panel</i> on page 58. • For Windows®: to perform the calibration using software, see <i>Calibration using software (for Windows®)</i> on page 59. • For Macintosh: to perform the calibration using software, see <i>Calibration using software (for Macintosh)</i> on page 62.

Troubleshooting

Scanning difficulties

Difficulty	Cause	Suggestions
My scanner does not turn on.	The supplied Micro USB Cable is not connected securely.	Make sure the Micro USB Cable is securely connected to your scanner and computer.
	The battery is low.	Connect the Micro USB Cable to your scanner and computer to charge the battery. If you charge the scanner's battery only a little from empty battery, you cannot use the scanner. Turn off the scanner until the battery is charged fully.
My computer does not recognize the scanner when it is connected via the Micro USB Cable.	Causes may vary.	Make sure the Micro USB Cable is securely connected to your scanner and computer. Remove the Micro USB Cable and reconnect the Micro USB Cable to your scanner and computer.
My scanned images have black lines running through them, blank spaces, or are of overall bad quality.	This problem occurs if the scanner is not calibrated correctly or if a foreign object, such as a paper clip or ripped paper, is stuck in the scanner.	<ol style="list-style-type: none"> 1. Check the document feeder slot and make sure that the slot is clear. If foreign objects are found, remove them from your scanner. 2. Calibrate your scanner (see <i>Scanner Calibration</i> on page 58). <p>If scan quality is not improved after you calibrate your scanner:</p> <ol style="list-style-type: none"> 1. Clean the scanner (see <i>Scanner Maintenance</i> on page 64). 2. Calibrate your scanner again.
My scanned image is missing.	The Document Guides are not adjusted to fit the width of the document.	Adjust the Document Guide to fit the width of the document.
	The settings are not suitable for your document. For example, a A4 document was fed when Letter was selected as document size.	Make sure the document size settings are suitable for your document. For Windows®: see <i>Paper settings</i> on page 29. For Macintosh: see <i>Paper settings</i> on page 39.
The scan speed is too slow.	The resolution is not suitable for your document.	Decrease the scanner resolution. For Windows®: see <i>Image settings</i> on page 28. For Macintosh: see <i>Image settings</i> on page 36.

Difficulty	Cause	Suggestions
My scanner is connected but it will not feed my document or do anything else.	Your document is not set correctly.	Insert your document until you feel the top edge of the document touch the inside of your scanner.
	Your document is too thin or too thick.	Check that your document is acceptable (see <i>Document Specifications</i> on page 12). If your document is not the problem: 1. Confirm that the Micro USB Cable connecting your scanner to your computer is properly connected. 2. Reinstall the scanner driver from the DVD-ROM.
	The scanner's top cover is open.	Close the top cover and start scanning again.
	The scanner is turned off because the auto power off function is active.	Press the Power button to turn on the scanner.
	You are operating the settings menu. (SD mode only)	Get out of the settings menu to put the scanner into standby mode.
	No SD card is inserted in the scanner's SD card slot. (SD mode only)	Insert an SD card into the scanner's SD card slot.
The document is jammed.	Causes may vary.	Open the scanner's top cover and gently pull out the document. Make sure that no piece of paper remains in the scanner.
	Your document is not acceptable for the machine (for example, if the paper is too long).	<ul style="list-style-type: none"> ■ Make sure your document is acceptable for the machine (see <i>Document Specifications</i> on page 12). ■ Use the supplied Carrier Sheet (see <i>Loading the Carrier Sheet</i> on page 16).
My scanner gets warm.	It is normal for your scanner to emit a small amount of heat after prolonged use.	If there is a strange smell coming from the scanner or the scanner feels a little bit hot to the touch, immediately remove the Micro USB Cable from your scanner and computer.
The scan quality is poor.	Paper dust has accumulated inside your scanner.	Clean your scanner (see <i>Scanner Maintenance</i> on page 64).
	Calibration needs to be performed.	Perform the calibration. <ul style="list-style-type: none"> • To perform the calibration using the control panel, see <i>Calibration using the control panel</i> on page 58. • For Windows®: to perform the calibration using software, see <i>Calibration using software (for Windows®)</i> on page 59. • For Macintosh: to perform the calibration using software, see <i>Calibration using software (for Macintosh)</i> on page 62.
	The scanner resolution is too low.	Increase the scanner resolution. For Windows®: see <i>Image settings</i> on page 28. For Macintosh: see <i>Image settings</i> on page 36.

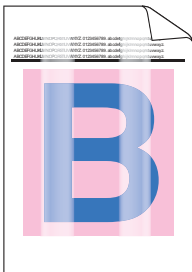
Difficulty	Cause	Suggestions
<p>Colors in the scanned image are dark.</p>	<p>The settings are not appropriate for the type of document being scanned.</p>	<p>Adjust the scanning settings. For Windows®: see <i>Image settings</i> on page 28. For Macintosh: see <i>Image settings</i> on page 36.</p>
	<p>Calibration needs to be performed.</p>	<p>Perform the calibration.</p> <ul style="list-style-type: none"> To perform the calibration using the control panel, see <i>Calibration using the control panel</i> on page 58. For Windows®: to perform the calibration using software, see <i>Calibration using software (for Windows®)</i> on page 59. For Macintosh: to perform the calibration using software, see <i>Calibration using software (for Macintosh)</i> on page 62.
<p>OCR feature does not work.</p>	<p>The scanner resolution is too low.</p>	<p>Increase the scanner resolution. For Windows®: use PaperPort™ 12SE to increase the resolution. For Macintosh: use Presto! PageManager 9 to increase the resolution.</p>
	<p>(Windows® users) Nuance PaperPort™ 12SE has not been installed on your computer.</p>	<p>Make sure you have installed Nuance PaperPort™ 12SE from the supplied DVD-ROM.</p>
	<p>(Macintosh users) Presto! PageManager has not been installed on your computer.</p>	<p>Make sure you have installed Presto! PageManager from the supplied DVD-ROM.</p>
<p>The scanned image is skewed (slanted).</p>	<p>The scanner's Document Guide are not adjusted to fit the width of the document.</p>	<p>Adjust the Document Guide to fit the width of the document.</p>
<p>White vertical lines or white stripes appear on the scanned image.</p> 	<p>The scanner is under direct sunlight.</p>	<ul style="list-style-type: none"> Move the scanner indoors or to a place without sunlight to avoid the direct sunlight. Change the scanner's direction.
	<p>A light source is near the scanner.</p>	<ul style="list-style-type: none"> Move the scanner far away from the light source. Change the scanner's direction.

Difficulty	Cause	Suggestions
Bleed-through is seen in the scanned image.	Your document is too thin.	Check that your document is acceptable (see <i>Document Specifications</i> on page 12).
	The contrast setting is improper.	Increase the contrast level. For Windows®: see <i>Image settings</i> on page 28. For Macintosh: see <i>Image settings</i> on page 36.
When I want to scan in SD mode, is it possible to change the paper size, the image quality, etc. on my scanner?	You can change only part of the settings.	For more information about the settings, see step 4 of <i>Scanning in SD mode</i> on page 18.
(DS-920DW only) Duplex scanning cannot be performed.	The duplex scanning settings are not configured in DSmobileCapture .	Launch DSmobileCapture , click the Image tab, and then select the Duplex check box.
	The scan mode of the scanner is set to 1 side (in SD mode).	Press the scanner's 2 side / 1 side button so that 2 appears on the LCD.

Software difficulties

Difficulty	Cause	Suggestions
When I press Scan in my scanning software, an error message appears: Please install scanner or The scan was aborted because the scanner is not powered on or not connected properly .	This error message appears if your scanner isn't recognized by your computer.	1. Make sure your scanner is connected properly. 2. Confirm that the Micro USB Cable is working and that it is not frayed or damaged in any way. If the error still appears after verifying that the Micro USB Cable is connected properly, reinstall the scanner driver from the DVD-ROM.
I cannot install the scanner drivers. (Windows®)	You may not have been given administrator privileges.	Log into Windows® with administrator rights.
I cannot install the scanner drivers. (Macintosh)	You may not have been given administrator privileges.	From Apple menu, select System Preferences > System > Users & Groups . The left pane of the window will list the current accounts, one of which should be your name with the word "Admin" underneath. If this is <u>not</u> the case, contact your system administrator.

Difficulty	Cause	Suggestions
The file size is too large.	The size of the file will depend upon many factors. The physical size of the document and the amount of text / graphics on each page are factors that will affect the resulting file size. These factors cannot be changed.	To produce the smallest scan file for a given document, use the lowest resolution and Black and White mode, and scan the smallest area possible. Using the opposite settings (scanned in the highest resolution, in the Color mode, and scanning the largest area possible) will produce the largest-sized file. For Windows®: see <i>Changing DSmobileCapture scan settings (for Windows®)</i> on page 27). For Macintosh: see <i>Changing DSmobileCapture scan settings (for Macintosh)</i> on page 36).

Network difficulties

Difficulty	Cause	Suggestions
My wireless device (computer, smart-phone, tablet, etc.) cannot access my scanner via the wireless LAN network.	The Wi-Fi® switch of the scanner is set to OFF .	Slide the Wi-Fi® switch to ON .
	Four or more wireless devices are connected to your scanner at a time.	Disconnect the wireless devices that are already connected to the scanner. Then, try to connect three or fewer wireless devices to the scanner.
	Causes may vary.	Set the Wi-Fi® switch to OFF , then set it to ON to reconnect the scanner.
I forgot the login password to enter the Home screen on the browser.	Causes may vary.	Reset the network settings (see <i>Reset network settings</i> on page 57).

Other difficulties

Difficulty	Cause	Suggestions
I do not have or lost the Calibration Sheet.	Causes may vary.	The special glossy calibration sheet that came with your scanner will give you the best calibration results. To order a new Calibration Sheet, go to Brother Mall at http://www.brothermall.com .
I want use a USB hub.	Causes may vary.	Use your scanner without connecting to a USB hub. A USB hub may not be able to supply enough power to the scanner.
I cannot charge my scanner.	The scanner is on while you are trying to charge it.	Turn the scanner off when you charge it.
	The Li-ion battery is not installed correctly.	Make sure the Li-ion battery is installed in the correct direction (see the <i>Quick Setup Guide</i>).

Difficulty	Cause	Suggestions
My scanner cannot be turned on or is turned off immediately.	The battery has not been inserted.	Insert the battery.
	The battery has been inserted in the wrong direction.	Insert the battery in the correct direction. For more information, see <i>Installing the battery</i> on page 9.
	<ul style="list-style-type: none"> The battery is empty. The battery is low. The scanner's Wi-Fi® switch is ON. 	Do one of the following: <ul style="list-style-type: none"> Slide the scanner's Wi-Fi® switch to OFF to use the scanner. Connect the Micro USB Cable to your scanner and your computer to use the scanner. If you cannot turn on the scanner when you press the Power button, wait for two minutes, and then press the Power button again. Turn off the scanner and connect the Micro USB Cable to your scanner and your computer until the battery is charged fully. And then use the scanner.
When I set the Wi-Fi® switch to ON , the Wi-Fi® indicator does not turn on.	The battery is low.	Connect the Micro USB Cable to your scanner and your computer to charge the battery.
	The Li-ion battery is not installed.	Install the battery, and then charge it.
I lost the Li-ion battery or I cannot charge the battery.	Causes may vary.	Contact Brother Mall at http://www.brothermall.com .
My computer cannot access the SD card via the Micro USB Cable.	The Micro USB Cable is not connected to your computer.	Connect the Micro USB Cable to your scanner and your computer.
	Your scanner is in TWAIN mode.	Press the Start / OK button, and then display SD on the LCD to change to Mass Storage mode (SD mode).
	The Wi-Fi® switch is set to ON .	Slide the Wi-Fi® switch to OFF .
	A document is being scanned.	When the scanning is finished, wait for the SD card's folder to be displayed on your computer screen.
When I type http://10.10.100.1 to access the home screen in the web browser, the scanned images stored on the scanner's SD card are not displayed on the home screen.	Your scanner is in TWAIN mode.	Press the Start / OK button, and then display SD on the LCD to change to Mass Storage mode (SD mode).
	Your scanner is scanning a document.	Display the web browser again when scanning is complete.

Difficulty	Cause	Suggestions
My scanner cannot be put into TWAIN mode.	The scanner's Wi-Fi® switch is ON .	Slide the Wi-Fi® switch to OFF and select TWAIN mode on the computer (see <i>Connecting your scanner to your computer in TWAIN Mode</i> on page 23).
I set the auto power off to ON but my scanner does not turn off automatically.	The Wi-Fi® switch is set to ON .	Slide the Wi-Fi® switch to OFF .

A

Appendix A

Specifications

NOTE

This chapter provides a summary of the scanner's specifications. For additional specifications, go to your scanner's product page at <http://www.brother.com/> and click the **Specifications** tab.

General

			DS-820W	DS-920DW
Power Source		USB bus-power / Li-ion battery		
Power consumption ¹	Scanning / Battery Charging	5 V / 500 mA or less		
	Battery full-charged / Power Off	5 V / 1 mA or less		
Dimensions	Width	12.1 in. (308.0 mm)		
	Height	1.6 in. (40.7 mm)	1.6 in. (41.2 mm)	
	Depth	2.1 in. (52.5 mm)	2.6 in. (66.9 mm)	
Weight		Approx. 0.97 lb (440 g)	Approx. 1.17 lb (530 g)	
Temperature		Operating	41 to 95 °F (5 °C to 35 °C)	
Humidity		Operating	15 to 85 %	
		Storage	10 to 90 %	
Document Size	Single Paper	Width	2.2 in. to 8.5 in. (55 mm to 215.9 mm)	
		Length	1 side scan 3.5 in. to 32 in. (90 mm to 812.8 mm)	
			-	2 side scan 3.5 in. to 16 in. (90 mm to 406.4 mm)

¹ Measured when the scanner is connected to your computer.

Scanner

		DS-820W	DS-920DW
Color / Black		Yes / Yes	
Duplex Scan		No	Yes
TWAIN Compliant	Windows®	Windows® XP ¹ / Windows Vista® / Windows® 7 / Windows® 8	
	Macintosh	Mac OS X 10.6.x, 10.7.x, 10.8.x ²	
Color Depth	Input	48 bit color Processing	
	Output	24 bit color Processing	
Resolution	Optical	Up to 600 × 600 dpi	
	Interpolated	1200 dpi	
Scanning Width		Up to 8.5 in. (216 mm)	
Gray Scale	Input	16 bit	
	Output	8 bit	
Scanning Max. Speed		Mono 8.0 ppm (7.5 seconds (Letter) up to 300 dpi) 7.5 ppm (8 seconds (A4) up to 300 dpi) 4.3 ppm (14.1 seconds (Letter) above 400 dpi) 4 ppm (15 seconds (A4) above 400 dpi) Color 8.0 ppm (7.5 seconds (Letter) up to 300 dpi) 7.5 ppm (8 seconds (A4) up to 300 dpi) 4.3 ppm (14.1 seconds (Letter) above 400 dpi) 4 ppm (15 seconds (A4) above 400 dpi)	
Duplex Scanning Max. Speed		-	Mono 5.3 ppm (11.3 seconds (Letter) up to 300 dpi) 5 ppm (12 seconds (A4) up to 300 dpi) 3 ppm (19.8 seconds (Letter) above 400 dpi) 2.9 ppm (21 seconds (A4) above 400 dpi) Color 5.3 ppm (11.3 seconds (Letter) up to 300 dpi) 5 ppm (12 seconds (A4) up to 300 dpi) 3 ppm (19.8 seconds (Letter) above 400 dpi) 2.9 ppm (21 seconds (A4) above 400 dpi)

¹ Windows® XP in this User's Guide includes Windows® XP Home Edition and Windows® XP Professional.

² For the latest driver updates for the Mac OS X you are using, visit us at <http://solutions.brother.com/> and click "Downloads" from your model page.

Li-ion battery

	DS-820W	DS-920DW
Charging time	4 hours	
Continuous standby time (WLAN OFF)	5 minutes (when the auto power function is active.)	
Scannable number of sheets (WLAN ON)	90 sheets	140 sheets
Scannable number of sheets (WLAN OFF)	450 sheets	680 sheets

NOTE

- The numbers described in the Li-ion battery table may differ depending on the scanning document and on environmental factors, such as temperature and the charging and discharging method.
- For longer battery life:
 - Slide the Wi-Fi® switch to **OFF** when you are not using the Wi-Fi® function.
 - Turn the scanner off when you are not using it.

Interfaces

USB	Hi-Speed USB 2.0 ^{1 2} Use a USB 2.0 cable (Type A / B) that is no more than 4 feet (1.2 meters) long.
SD card	SD card memory size limit: between 2GB - 32GB When you do not use the SD card that came with your scanner, any operation is not guaranteed.
Wireless LAN	IEEE 802.11b/g/n

¹ Your scanner has a Hi-Speed USB 2.0 interface. The scanner can also be connected to a computer that has a USB 1.1 interface.

² Third party USB ports are not supported.

Network

		DS-820W	DS-920DW
Network (common)	Protocol (IPv4)	ARP, DNS Resolver, HTTP, ICMP, DHCP with BOOTP	
Network Security	Wireless	SSL/TLS (HTTPS)	
Wireless Network Security		WEP 64/128 bit, WPA-PSK (AES), WPA2-PSK (AES)	WEP 64/128 bit, WPA-PSK (TKIP/AES), WPA2-PSK (AES)
Wireless Certification		Wi-Fi Certification Mark License (WPA™/WPA2™, Personal)	

Computer requirements

SUPPORTED OPERATING SYSTEMS AND SOFTWARE FUNCTIONS							
Computer Platform & Operating System Version		Processor Minimum Speed	Minimum RAM	Recommended RAM	Hard Disk Space to install		Supported PC Interface
					For Drivers	For Applications	
Windows® Operating System	Windows® XP Home Windows® XP Professional	Intel® Core™2 Duo or equivalent	1 GB	2 GB	80 MB	1.2 GB	USB
	Windows® XP Professional x64 Edition	64-bit (Intel®64 or AMD64) supported CPU	1 GB	2 GB			
	Windows Vista®	Intel® Core™2 Duo or equivalent 64-bit (Intel®64 or AMD64) supported CPU	1 GB	2 GB	80 MB	1.2 GB	
	Windows® 7	Intel® Core™2 Duo or equivalent 64-bit (Intel®64 or AMD64) supported CPU	1 GB (32-bit) 2 GB (64-bit)	2 GB (32-bit) 4 GB (64-bit)	80 MB	1.2 GB	
	Windows® 8	Intel® Core™ i3 or equivalent 64-bit (Intel®64 or AMD64) supported CPU	1 GB (32-bit) 2 GB (64-bit)	2 GB (32-bit) 4 GB (64-bit)	80 MB	1.2 GB	
Macintosh Operating System	Mac OS X 10.6.x	Intel® Processor	1 GB	2 GB	80 MB	400 MB	USB
	Mac OS X 10.7.x	Intel® Processor	1 GB	2 GB			
	Mac OS X 10.8.x	Intel® Processor	2 GB	4 GB			

For the latest driver updates, visit <http://solutions.brother.com>

All trademarks, brand and product names are property of their respective companies.

Contacting Brother

IMPORTANT

For technical help, contact the Customer Service center in the country where you bought the scanner. For more information, see *For customer service* on page 80. Calls must be made **from within** that country.

Register your product

By registering your product with Brother International Corporation, you will be recorded as the original owner of the product. Your registration with Brother:

- may serve as confirmation of the purchase date of your product should you lose your receipt
- may support an insurance claim by you in the event of product loss covered by insurance
- will help us notify you of enhancements to your product and special offers

Complete and fax the Brother Warranty Registration And Test Sheet or, for your convenience and most efficient way to register your new product, register online at

<http://www.brother.com/registration/>

Frequently asked questions (FAQs)

The Brother Solutions Center is our one-stop resource for all your Brother machine needs. You can download the latest software documents and utilities, read FAQs and troubleshooting tips, and learn how to get the most from your Brother product.

<http://solutions.brother.com/>

You can check the Brother Solutions Center for Brother driver updates.

To keep your machine performance up to date, check the Brother Solutions Center for the latest firmware upgrade.

For customer service

In USA: 1-877-BROTHER (1-877-276-8437)
1-901-379-1215 (fax)
For the location of a Brother authorized service center, call 1-877-BROTHER (1-877-276-8437).

In Canada: 1-877-BROTHER
(514) 685-4898 (fax)
For the location of a Brother authorized service center, call 1-877-BROTHER.

If you have comments or suggestions, please write us at:

In USA: Printer Customer Support
Brother International Corporation
7905 North Brother Boulevard
Bartlett, TN 38133

In Canada: Brother International Corporation (Canada), Ltd.
- Marketing Dept.
1, Rue Hotel de Ville Dollard-des-Ormeaux, PQ, Canada H9B 3H6

Service center (USA only)

Visit <http://www.brother-usa.com/service/>.

Internet addresses

Brother Global Web Site: <http://www.brother.com/>

For Frequently Asked Questions (FAQs), Product Support and Technical Questions, Driver Updates and Utilities, and User's Guides: <http://solutions.brother.com/>

For Brother Accessories & Supplies:

In USA: <http://www.brothermall.com/>

In Canada: <http://www.brother.ca/>

Technical support (for PageManager and BizCard)

For USA

Company name: NewSoft America Inc.
Postal Address: 47102 Mission Falls Court, Suite 202 Fremont CA 94539
Telephone: 510-770-8900
Fax: 510-770-8980
E-mail Address: contactus@newsoftinc.com
URL: <http://www.newsoftinc.com>

For Canada

E-mail Address: contactus@newsoftinc.com

Other countries

E-mail Address: tech@newsoft.eu.com

NOTE

For all other issues, see *For customer service* on page 80.
